

**PRODUCT CATALOGUE**

# **MARSSA ENTERPRISE**

A complete Commercial kitchen solution



**Scan This QR For Connect With Us**

  **+91 9717778911**

 **marssa.enterprise@gmail.com**

# Company Profile

**Marssa Enterprise** is a Leading supplier of replacement parts, and servicing, of commercial equipment. Within 5 years of operation, we have built a solid reputation in the field. We work hard to stay ahead of the curve by staying up to date with the newest trends and technologies because the commercial kitchen business is always changing and evolving. Our industry-savvy team of professionals offers our clients the newest and most cutting-edge goods and services available.

## Products:

To satisfy the needs of eateries, lodging facilities, coffee shops, air caterers, and other food service enterprises, we provide a large selection of commercial kitchen equipment and replacement components. We have a wide range of products, from tiny appliances to huge equipment like ice makers and oven dishwashers. All of our products are built to be dependable, long-lasting, and simple to use using premium materials.

## Expert Advice

We understand that choosing the right equipment and services for your business can be a challenge, which is why we offer expert advice to help you make informed Decisions. Our knowledgeable staff is always available to answer your questions and provide you with the information you need to make the best decision for your business. Whether you are starting a new business or upgrading your existing equipment we can help you find the right products and services to meet your needs.

At Marssa Enterprise, we are dedicated to giving our clients the greatest experience possible. Our dedication to excellence, customer service, and professional guidance distinguishes us from other businesses in the sector. We can assist you with any needs you may have for servicing or replacement components for commercial kitchen equipment. To find out how we can support the success of your company, get in touch with us right now.

## Brands



# List of Clients



## Cafeteria



## Patisserie



## Hotels



## F & B



## BAKERY



**EVERY SINGLE REQUEST IS DEALT PERSONALLY  
BY OUR PEOPLE FOR YOUR BUSINESS**

**We always prioritise your health. Every plastic part that comes into touch with food is BPA-free. This chemical's absence helps to make the product safe for your health.**



### TRINITYPRO COMBINED VEGETABLE SLICER/CUTTER MIXER 3,6 LT - SINGLE SPEED

SUPPLY VOLTAGE	
	: 602160 (COM36)
	: 200-240 V/1N ph/50/60 Hz
Electrical power max.	: 0.5 kW
Total Watts	: 0.5 kW
CAPACITY	
RPM	: 1500rpm
KEY INFORMATION	
External dimensions, Width	: 348 mm
External dimensions, Depth	: 334 mm
External dimensions, Height	: 527 mm
Shipping weight	: 23 kg

### VEGETABLE SLICER TRS Vegetable Slicer - 1 Speed

SUPPLY VOLTAGE	
	: 600464 (TRS)
	: 200-240 V/1N ph/50/60 Hz
Electrical power max.	: 0.5 kW
Total Watts	: 0.5 kW
CAPACITY	
Performance (up to)	: 550 - kg/hour
KEY INFORMATION	
External dimensions, Width	: 252 mm
External dimensions, Depth	: 500 mm
External dimensions, Height	: 515 mm
Shipping weight	: 22 kg





**Electrolux**  
PROFESSIONAL



With so many different extra accessories to choose from, vegetable peelers may be used for a variety of tasks, including washing, scouring, peeling, and even drying.



T10E / T15E



T25E

MODEL	601792 (T10E1)	601900 (T15E1)	602010 (T25EF150)
Supply Voltage	: 220-240 V/1N ph/50/60 Hz	220-240 V/1N ph/50/60 Hz	220-240 V/1N ph/50/60 Hz
Electrical power max.	: 0.37 kW	0.37 kW	1.1 kW
Total Watts	: 0.37 kW	0.37 kW	1.1 kW
<b>CAPACITY</b>			
Performance (up to):	: 160 - kg/hour	240 - kg/hour	400 - kg/hour
Capacity	: 10 kg	15 kg	25 kg
<b>KEY INFORMATION</b>			
External dimensions, Width	: 440mm	440 mm	585 mm
External dimensions, Depth	: 690mm	690 mm	785 mm
External dimensions, Height	: 680mm	750 mm	1215 mm
Shipping weight	: 48kg	50 kg	90 kg



Unloading hole



Abrasive plate and cylinder



Brushing plate



Drying basket (optional)

# 2 Door Refrigerator/ Freezer



## **2-DOOR REFRIGERATED COUNTER** **A304 R290 Product Code 790497**

- Adjustable temperature range from -2 °C to +8 °C to suit meat, fish and dairy storage requirements.
- Performance guaranteed at ambient temperatures of +38°C.
- Built-in compressor
- Worktop in AISI 304 Stainless Steel.
- External doors, front, back and side panels in AISI 304 Stainless Steel.

## **2-DOOR FREEZER COUNTER** **A304 R290 Product Code 790513**

- Performance guaranteed at ambient temperatures of +38°C.
- Adjustable temperature range from -18 °C to -22 °C to suit meat, fish, and dairy storage requirements.
- Worktop in AISI 304 Stainless Steel.
- Self-closing doors.
- External doors, front, back, and side panels in AISI 304 Stainless Steel.





**Electrolux**  
PROFESSIONAL

# 3 Door Refrigerator/ Freezer



## **3-DOOR REFRIGERATED COUNTER A304 R290 Product Code 790500**

- Adjustable temperature range from -2 °C to +8 °C to suit meat, fish, and dairy storage requirements.
- Performance guaranteed at ambient temperatures of +38°C.
- Internal panels and fittings in AISI 304 Stainless Steel.
- Built-in compressor
- Worktop in AISI 304 Stainless Steel.
- External doors, front, back, and side panels in AISI 304 Stainless Steel.

## **3-DOOR FREEZER COUNTER A304 R290 Product Code 790514**

- Performance guaranteed at ambient temperatures of +38°C.
- Adjustable temperature range from -18 °C to -22 °C to suit meat, fish, and dairy storage requirements.
- Internal panels and fittings in AISI 304 Stainless Steel.
- Worktop in AISI 304 Stainless Steel.
- External doors, front, back and side panels in AISI 304 Stainless Steel.

# 2 X 1/2 Half Door Refrigerator/ Freezer



## 2x1/2-DOOR REFRIGERATED CABINET A304 R600a Product Code 790478

- Adjustable temperature range from -2 °C to +8 °C to suit meat, fish, and dairy storage requirements.
- Performance guaranteed at ambient temperatures of +38°C.
- Internal panels and fittings in AISI 304 Stainless Steel.
- Built-in compressor.
- External doors, front, back, and side panels in AISI 304 Stainless Steel.

## 2x1/2-DOOR FREEZER CABINET A304 R290 Product Code 790479

- Adjustable temperature range from -18 °C to -22 ° C to suit meat, fish, and dairy storage requirements.
- Performance guaranteed at ambient temperatures of +38°C.
- Internal panels and fittings in AISI 304 Stainless Steel.
- Built-in compressor.
- External doors, front, back, and side panels in AISI 304 Stainless Steel.

# 4 X 1/2 Half Door Refrigerator/ Freezer



## **4x1/2-DOOR REFRIGERATED CABINET** **A304 R290 Product Code 790480**

- Adjustable temperature range from -2 °C to +8 °C to suit meat, fish and dairy storage requirements.
- Performance guaranteed at ambient temperatures of +38°C.
- Internal panels and fittings in AISI 304 Stainless Steel.
- Built-in compressor.
- External doors, front, back and side panels in AISI 304 Stainless Steel.

## **4x1/2-DOOR FREEZER CABINET** **A304 R290 Product Code 790481**

- Performance guaranteed at ambient temperatures of +38°C.
- Adjustable temperature range from -18 °C to -22° C to suit meat, fish and dairy storage requirements.
- Internal panels and fittings in AISI 304 Stainless Steel.
- Built-in compressor.
- External doors, front, back and side panels in AISI 304 Stainless Steel.

# 6 X 1/2 Half Door Refrigerator



**6x1/2-DRAWER REFRIGERATED COUNTER**  
**A304 R290 Product Code 790502**

- Adjustable temperature range from -2 °C to +8 °C to suit meat, fish and dairy storage requirements.
- Performance guaranteed at ambient temperatures of +38°C.
- Internal panels and fittings in AISI 304 Stainless Steel.
- Built-in compressor.
- Worktop in AISI 304 Stainless Steel.
- External doors, front, back and side panels in AISI 304 Stainless Steel.

# 1 Door Refrigerator/ Freezer



## 1-DOOR REFRIGERATED CABINET A304 R600a Product Code 790486

- Adjustable temperature range from -2 °C to +8 °C to suit meat, fish and dairy storage requirements.
- Performance guaranteed at ambient temperatures of +38°C.
- Developed and produced in ISO 9001 and ISO 14001 certified factory.
- Internal panels and fittings in AISI 304 Stainless Steel.
- Built-in compressor.
- External doors, front, back and side panels in AISI 304 Stainless Steel.

## 1-DOOR FREEZER CABINET A304 R290 Product Code 790487

- Performance guaranteed at ambient temperatures of +38°C.
- Adjustable temperature range from -18 °C to -22 °C to suit meat, fish and dairy storage requirements.
- Developed and produced in ISO 9001 and ISO 14001 certified factory.
- Internal panels and fittings in AISI 304 Stainless Steel.
- Built-in compressor.
- External doors, front, back and side panels in AISI 304 Stainless Steel.



## Cold Beverage Dispensers

### SIMPLICITY BUBBLERS

Your choice, limitless flavor, in one simple answer. Flexible choices, safe and easy to use, cold beverage dispensers are the answer to offering your customers innovative, delicious new drink options.

PNC	Description	Dimensions (w x d x h)
600925	2x9 ltrs. bowls, agitator	267x451x729 mm
600935	3x9 ltrs. bowls, agitator	518x451x818 mm
600931	4x9 ltrs. bowls, agitator	521x451x729 mm
600933	1x18 ltrs. bowl and 2x9 ltrs. bowls, agitator	521x451x729 mm
600927	1x18 ltrs. bowl, agitator	267x451x729 mm
600932	2x18 ltrs. bowls, agitator	521x451x729 mm

Temperature range from 1.7 - 5° C.

Refrigerant type: R290

Pre-mix dispenser with stainless steel base and clear plastic bowls.

User friendly design enables machine to dispense product till the very last drop



A chef wearing a white toque and a white chef's jacket with a dark blue collar is focused on cooking. He is using a pair of metal tongs to handle a piece of food in a stainless steel pan on a stove. The kitchen background is slightly blurred, showing shelves with various kitchen items. A semi-transparent grey banner is overlaid across the middle of the image, containing the text 'COOKING TECHNOLOGY'.

**COOKING TECHNOLOGY**



**Electrolux**  
PROFESSIONAL



### Gas Ranges on Convection/Static Oven (4 burners)

MODELS	391007	391008	391009	391010	391164
External dim. - mm					
width	800	800	800	800	800
depth	930	930	930	930	930
height	850	850	850	850	850
Gas power - kW	34,5	38,5	50,5	28	28
Electric power - kW	0,25	0,25	0,25	6	6
Burners - nr/kW	4x6	1x10+3x6	4x10	1x10+3x6	1x10+3x6
Gas convection oven	Yes	Yes	Yes	No	No
Electric Static oven	No	No	No	Yes	Yes
Electrical connection	230V 1N	230V 1N	230V 1N	400V 3N	230V 3N
	50Hz	50Hz	50Hz	50Hz	50Hz





**Electrolux**  
PROFESSIONAL



**Power & efficiency all in one!  
Boil, Braise, Grill, and fry with  
the most efficient burners  
available today**

**Gas Ranges on Static Oven (6 or 8 Burners)**

MODELS	391013	391014	391015	391016	391017
External dim. - mm					
width	1200	1200	1200	1200	1200
depth	930	930	930	930	930
height	850	850	850	850	850
Gas power - kW	52,5	68,5	56	72	73
Burners - nr/kW	2x10+4x6	6x10	2x10+4x6	6x10	2x10+6x6
Gas Static oven	Yes	Yes	No	No	No
Large oven	No	No	Yes	Yes	No
Open Cupboard	Yes	Yes	No	No	No



**Electric Ranges with Square Plates on Oven**

MODELS	391041	391167
External dim. - mm		
width	800	800
depth	930	930
height	850	850
Electric power - kW	22	22
Plates - nr	4x4	4x4
Electric Static oven	Yes	Yes
Electrical Connection	400V/3N	230V/3N
	50Hz	50Hz



### Gas Tilting Braising Pans (80lt/100lt)

MODELS	391134	391135	391136	391138	391139
External dim. - mm					
width	800	800	800	1000	1000
depth	930	930	930	930	930
height	850	850	850	850	850
Gas power - kW	21	21	21	27	27
Electric power - kW	0,25	0,25	0,25	0,25	0,25
Nominal well capacity - lt	80	80	80	100	100
Duomat bottom	No	No	Yes	No	No
Mild steel bottom	Yes	Yes	No	Yes	Yes
Motorized lifting	No	Yes	No	No	Yes
Electrical connection	230V 1N	230V 1N	230V 1N	400V 3N	230V 3N
	50Hz	50Hz	50Hz	50Hz	50Hz

### Electric Tilting Braising Pans (80lt/100lt)

MODELS	391143	391144	391145	391147	391148
External dim. - mm					
width	800	800	800	1000	1000
depth	930	930	930	930	930
height	850	850	850	850	850
Electric power - kW	13	13	13	17	17
Nominal well capacity - lt	80	80	80	100	100
Duomat bottom	No	No	Yes	No	No
Mild steel bottom	Yes	Yes	No	Yes	Yes
Motorized lifting	No	Yes	No	No	Yes
Electrical connection	400V 3N	400V 3N	400V 3N	400V 3N	400V 3N
	50Hz	50Hz	50Hz	50Hz	50Hz



## SkyLine Pro Combi Boilerless Oven Digital 6GN1/1 electric 217920



	<b>217920</b>
Number of grids	6
Runner pitch - mm	67
External dimensions - mm	
width	867
depth	775
height	808
Electric power - kW	11
Electric amperage - A	16,3
Electrical connection	380-415V 3N 50/60 Hz
Bakery (400x600 mm)	

## SkyLine Pro Combi Boilerless Oven Digital 10GN1/1 electric 217922



	<b>217922</b>
Number of grids	10
Runner pitch - mm	67
External dimensions - mm	
width	867
depth	775
height	1058
Electric power - kW	19
Electric amperage - A	28,3
Electrical connection	380-415V 3N 50/60 Hz
Bakery (400x600 mm)	

Model RCS511TS



‘-Microwave 1100W professional recommended for small volumes of use;-Ideal for fast food, can be used in snack bars, cafes, fast food, catering and small canteens; -The large room with a capacity of 34 liters allows to use large containers up to a size 2 / 3 GN containers or 2 1 / 3 GN; -Digital controls, 4 power levels, cycles of 3 kitchen timer, up to 60 minutes, 20 programs, magnetron 1.’

**MICROWAVE OVEN,DIGITAL,34LT,1100W**





# ***Dishwashing***

**Sparkling Clean Dishes Every Time**

## WAREWASHING

### Green & Clean Hood Type Dishwasher

**COD 505073**

Hood-type dishwasher, with single-skin manual hood,  
atmospheric boiler, 80r/h



## HOOD TYPE DISHWASHER, WITH SINGLE SKIN MANUAL HOOD, ATMOSPHERIC BOILER, 80R/H

### Main Features

- Requires only 2 liters of water per washing cycle thus ensuring low energy, water, detergent and rinse aid consumption.
- Built-in atmospheric boiler sized to raise incoming cold water to a minimum of 84 °C for sanitizing rinse. No external boiler is required. Constant temperature of 84 °C throughout the rinsing cycle regardless of the network's water pressure.
- Unique temperature interlock guarantees required temperatures in both the wash and final rinse.
- Incorporated Soft Start feature to offer additional protection to more delicate items.
- Slanted wash arms to avoid detergent-filled wash water dropping on clean dishes after the rinsing phase, thus guaranteeing ideal washing results.
- Cycle may be interrupted at any time by lifting the hood.
- Automatic self-cleaning cycle and selfdraining vertical wash pump and boiler to avoid bacteria proliferation.
- State-of-the-art electronic controls with builtin programming, self-diagnostics for serviceability and automatic interior self-cleaning cycle.
- IP25 protection against water jets, solid objects and small animals (larger than 6 mm).
- NSF/ANSI 3 and DIN 10512 compliant.
- Maximum capacity per hour of 80 racks or 1.440 dishes (High productivity mode) easy to switch to 63 racks or 1.134 dishes (NSF/ANSI 3 mode) by pressing a button.
- 45/84/150 seconds cycles (High productivity mode); 57/84/150 seconds cycles (NSF/ANSI 3 mode).
- The machine can be connected to cold water\*.



### CONSTRUCTION

- Heavy duty Stainless steel construction. Internal cavity as well as exterior panels are in 304 series Stainless steel.
- Pressed tank in front position to facilitate cleaning.
- Single skin hood supported by 3 springs to ensure smooth movement and guarantee operator safety.
- Specially designed Stainless steel wash/rinse arms and nozzles provide superior cleaning action.



**ELECTRIC**

Supply Voltage: 505073 (EHT8ROW) 400 V/3N ph/50Hz  
 Convertible to 230V 1N~; 230V 3~  
 Default Installed Power 9.9 kW

**Boiler Heating Elements**

Power \*9 kW  
 Tank heating elements 3 kW

**Water:**

Water supply temperature\* 10-65° C  
 Drain line size 20.5 mm  
 Inlet water supply pressure 0.5-7 bar

**Water consumption per**

Cycle (lt)\*\* 2  
 Boiler Capacity (lt) 12  
 Tank Capacity (lt) 24

**Key Information**

No. of cycles 3  
 Duration cycle \*45/84/150 sec.

**Duration cycle- NSF/ANSI**

3 compliant 57/84/150 sec.  
 Racks per hour \*80

**Racks per hour – NSF/ANSI**

3 compliant 1134  
 Wash temperature 55-65° C

**Wash temperature – NSF/**

ANSI 3 compliant 75° C  
 Rinse temperature 84° C

External dimensions, Width 746 mm

External dimension, Height 1549 mm

External dimension, Depth 755 mm

Net weight 106 kg

Shipping weight 117 kg

Shipping volume 1.23 m<sup>3</sup>

**Packaging size**

WxDxH 870 X 720 X 1630 mm

Noise level <68 dBA

\*\* When connected to cold water, the cycle time will be prolonged accordingly. The machine will have productivity per hour of 48 racks at 10° C supply temperature or 55 racks at 20° C supply temperature.

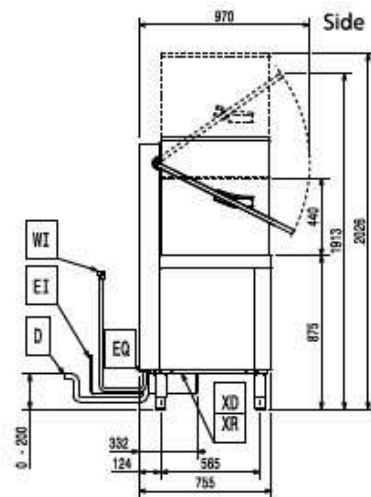
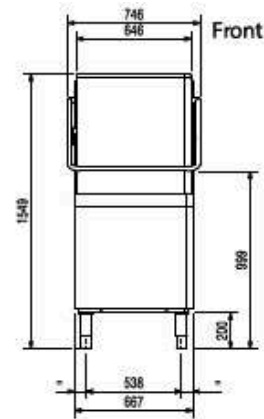

- CW1 = Cold Water inlet 1
- D = Drain
- EI = Electrical inlet (power)
- EO = Electrical Outlet
- HWI = Hot water inlet
- WI = Water inlet

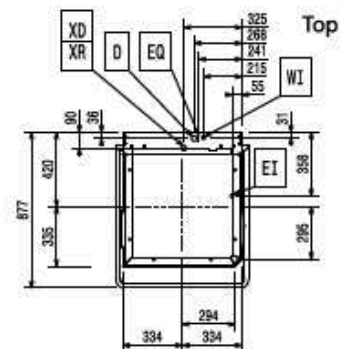



# Warewashing Small Single Skin Glasswasher and rinse aid dispenser, 30b/h

**ZANUSSI**  
PROFESSIONAL



## Main Features

- Deep drawn pressed wash tank with fully rounded corners, sloped towards the drain to prevent dirt build up provides fast drainage in only a few minutes. Pressed wash tank with no welded points offer a guaranteed water tight solution.
- Maximum capacity of 30 racks per hour.
- Equipped with single phase electrical cable and Schuko plug for easy and fast installation.
- Easy service access to main components without moving the unit.
- Built-in rinse aid dispenser with automatic initial and continuous cycle loading for perfect result while minimizing service and maintenance needs.
- 120 seconds cycle.
- Built-in pressure boiler designed to raise incoming water to a guaranteed minimum temperature of 82°C for sanitizing rinse. No external boiler is required.
- Washing system endowed with rotating washing arms, high powered wash pump and large capacity wash tank for professional washing.

## WAREWASHING

*Undercounter WSC, Single skin, drain pump, detergent & rinse aid dispenser, 400220 (ELA3G)*



### Key Information

Baskets per hour\*: **30**

Dishes per hour: **540**

Working cycles time (sec.): **120/180/240**

Wash temperature: **55-65°C**

Cell dimensions - width: **500 mm**

Cell dimensions - depth: **500 mm**

Cell dimensions - height: **330 mm**

Rinse temperature: **84 °C**

External dimensions, Width: **600 mm**

External dimensions, Depth: **648 mm**

External dimensions, Height: **820 mm**

Packaging size

(WxDxH): **740x640x1020 mm**

### Sustainability

Water supply temperature\*: **50 °C**

Water consumption per cycle (lt): **3**

Noise level: **<70 dBA**

### Water

Pressure, bar min/max: **0.5-7 bar**

Drain line size: **20.5mm**

Inlet Water supply pressure: **7 - 102 psi (0.5 - 7 bar)**

Washing tank capacity (lt): **33**

Boiler Capacity (lt): **5,8**

### Electric

Supply voltage: **400 V/3N ph/50 Hz**

Convertible to: **230V 3~; 230V 1N~**

Default Installed Power: **5.35 kW**

Boiler heating elements: **4,5 kW**

Tank heating elements: **2 kW**

Wash pump size: **0.736 kW**

**Authorized, Electrolux Professional Spare Parts, Accessories, Consumables Stockists**



MAIN BOARD HOOD  
TYPE DISHWASHER



HEATING ELEMENT HOOD  
TYPE DISHWASHER



RELAY HOOD  
TYPE DISHWASHER



JUNCTION BOX HOOD  
TYPE DISHWASHER



RFI FILTER HOOD  
TYPE DISHWASHER



SPRING  
CONVEYOR DISHWASHER



WASH PUMP  
CONVEYOR DISHWASHER



SOLENOID VALVE  
DISHWASHER



MAIN BOARD  
COMBI OVEN



GAS VALVE  
OVEN



GAS TAP  
HOT PLATE



PILOT BURNER  
HOT PLATE



RELIABILITY BUILT IN

# Pre-Rinse Units / Faucets / Hose Reels



## Model : EX-1DP00-H

### Product Specifications:

Pre-Rinse Unit: Single Lever Deck Mount Faucet, 24" Riser, 2 Saddleback Cove / P.O. Box 1088  
44" Flexible Stainless Steel Hose, 5SV-H High Flow Spray Valve, Travelers Rest, SC 29690  
6" Wall Bracket 18" Flexible Steel Supply Hoses w/Check Valves



## Model : EX-6WP00-H

### Product Specifications:

Pre-Rinse Unit: Single lever Wall Mount Base Faucet, 18" Riser, 44" Flexible 2 Saddleback Cove/P.O. Box 1088 Stainless Steel Hose, High Flow Spray Valve, 6" Wall Bracket & G 1/2" Male Inlets



## Model : EX-1DP12-H

### Product Specifications:

Pre-Rinse Unit: Single Lever Deck Mount Faucet, Add-On Faucet, 12" Swing Nozzle, 18" Riser, 44" Flexible Stainless Steel Hose, 5SV-H High Flow Spray Valve, 6" Wall Bracket, 18" Flexible Supply Hoses w/ Check Valves



## Model : EX-6WP12-H

### Product Specifications:

Pre-Rinse Unit: Single Lever Wall Mount Base Faucet, Add-On 2 Saddleback Cove / P.O. Box 1088 Faucet, 12" Swing Nozzle w/ Full Flow Aerator, 18" Riser, 44" Flexible Stainless Steel Hose, High Flow Spray Valve & 6" Wall Bracket



## Model : B-0113-B

### Product Specifications:

Single hole deck mount mixing faucet with polished chrome plated brass body, 24" riser, 44" flexible stainless steel hose with heat resistant handle, 1.15 GPM spray valve, compression cartridges with spring checks, lever handles, 18" flexible stainless steel supply hoses with 1/2" NPSM / 5/8" compression connections, 6" adjustable wall bracket, spray valve holder and overhead spring.



## Model : B-0133-B

### Product Specifications:

Pre-Rinse Unit: EasyInstall 8" Wall Mount Mixing Faucet, Quarter-Turn Eterna Cartridges w/ Spring Checks, Lever Handles, 44" Flexible Stainless Steel Hose, 1.15 GPM Spray Valve, 6" Wall Bracket & 1/2" NPT Female Inlets

## Model : 5HR-242-01

Hose Reel, Open, Powder Coated Steel, 50' x 3/8" ID Hose with Spray Valve

### Features & Benefits :

Open coated hose reel  
Black high flow spray valve  
3/8" x 50' hose  
Ratcheting system holds the length of hose until a slight tug to retract automatically 3/8" NPT female inlet  
Adjustable hose bumper  
Multi-fit bracket for wall, ceiling or under counter mounting

### Details :

Box Dimensions: 23x21x9  
Weight: 55.00 lbs (24.95 kg)  
UPC: 671262581967, Harmonize: 8424.20.0000

## Model : 5HR-232-01

Hose Reel, Open, Powder Coated Steel, 35' x 3/8" ID Hose with Spray Valve

### Features & Benefits :

Open coated hose reel  
Black high flow spray valve  
3/8" x 35' hose  
Ratcheting system holds the length of hose until a slight tug to retract automatically 3/8" NPT female inlet  
Adjustable hose bumper  
Multi-fit bracket for wall, ceiling or under counter mounting

### Details :

Box Dimensions: 19x16x7.5  
Weight: 34.05 lbs (15.44 kg)  
UPC: 671262581912  
Harmonize: 8424.20.0000



# ***Chill Line***





**DIGITAL CONTROL** *Touch a button to quickly change the defrost and temperature settings.*



Total control in only 4 buttons



**PRG/MUTE**  
Set the service parameters or mute the audible alarm



**ON/OFF button "UP"**  
To increase temperature



**SET**  
Set internal cavity temperature and technical parameters



**MANUAL DEFROST**  
Activates the defrost cycle "DOWN"  
To decrease temperature



Product code	790132	790133	790128	790129	790134	790135	790130	790131
External* / internal panels in AISI	304	304	304	304	304	304	304	304
Operating temperature at 43°C	-2/10	-22/-15	-2/10	-22/-15	-2/10	-22/-15	-2/10	-22/-15
Gross Capacity - lt	600	600	600	600	1300	1300	1300	1300
External dimensions - mm (wxdxh)	720x788x2000	720x788x2000	720x788x2000	720x788x2000	1440x788x2000	1440x788x2000	1440x788x2000	1440x788x2000
N° and type of grids (included)	3, GN 2/1	3, GN 2/1	4, GN 2/1	4, GN 2/1	6, GN 2/1	6, GN 2/1	8, GN 2/1	8, GN 2/1
Refrigeration type	R404a	R404a	R404a	R404a	R404a	R404a	R404a	R404a
Voltage/Phases/Frequency**	230/1/50	230/1/50	230/1/50	230/1/50	230/1/50	230/1/50	230/1/50	230/1/50



Product code	790096	790097	790098	790099	790100
With upstand	790108	790109	790110	790111	790112
Without worktop	790094	on request	on request	on request	on request
External* / internal panels in AISI	304	304	304	304	304
Operating temperature at 43°C	-2/10	-2/10	-2/10	-2/10	-2/10
Gross Capacity - lt	265	265	265	265	265
External dimensions - mm (wxdxh)	1238x710x850	1238x710x850	1238x710x850	1238x710x850	1238x710x850
N° and type of grids (included)	2, GN 1/1	1, GN 1/1	1, GN 1/1	-	-
Refrigeration type	R404a	R404a	R404a	R404a	R404a
Voltage/Phases/Frequency**	230/1/50	230/1/50	230/1/50	230/1/50	230/1/50



Product code	790101	790102	790103	790104	790105	790106	790107
With upstand	790113	790114	790115	790116	790117	790118	790119
Without worktop	790095	on request	on request	on request	on request	on request	on request
External* / internal panels in AISI	304	304	304	304	304	304	304
Operating temperature at 43°C	-2/10	-2/10	-2/10	-2/10	-2/10	-2/10	-2/10
Gross Capacity - lt	420	420	420	420	420	420	420
External dimensions - mm (wxdxh)	1721x710x850	1721x710x850	1721x710x850	1721x710x850	1721x710x850	1721x710x850	1721x710x850
N° and type of grids (included)	3, GN 1/1	2, GN 1/1	2, GN 1/1	1, GN 1/1	1, GN 1/1	-	-
Refrigeration type	R404a	R404a	R404a	R404a	R404a	R404a	R404a
Voltage/Phases/Frequency**	230/1/50	230/1/50	230/1/50	230/1/50	230/1/50	230/1/50	230/1/50

\* Models with external panels in stainless steel and internal panels in AISI 304 available on request

\*\* 60Hz models available on request



## Main Features

- **Gross Volume: 550 Liters**
- **Product Dimension (WDXH)mm: 770X740X1970**
- **Temperature Range: 0°C to 10°C**
- **No of Glass Door: 2**
- **Light Inside (With Switch): LED**
- **Glow Sign (With Switch): Available/LED**



## **Voltas Hard Top Convertible Freezers Double Door 277 Liters, 3 Star**

### **Main Features**

- **Gross Volume: 277 L**
- **Energy Rating: 3 Star**
- **Product Dimension(WxDxH): 1180 x 665 x 830**
- **Temperature Range: <-18°C (Freezer), 0° to 7°C (Cooler)**





## **Voltas Hard Top Convertible Freezers - Double Door 177 Liters, 2 Star**

### **Main Features**

- **Gross Volume: 177 L**
- **Energy Rating: 2 Star**
- **Product Dimension(WxDxH): 834 x 665 x 830**
- **Temperature Range: <-18°C (Freezer), 0° to 7°C (Cooler)**



## **Voltas Hard Top Convertible Freezers - Double Door 421 Liters, 4 Star**

### **Main Features**

- **Gross Volume: 421 L**
- **Product Color: Grey**
- **Energy Rating: 4 Star**
- **Product Dimension(WxDxH): 1680 x 665 x 830**
- **Temperature Range: <-18°C (Freezer), 0° to 7°C (Cooler)**



## **Voltas Flat Glass Top Freezers - 275 Liters, 5 Star**

### **Main Features:**

- **Gross Volume: 275 L**
- **Energy Rating: 5 Star**
- **Product Dimension(WxDxH): 1180 x 620 x 855**
- **Temperature Range: <-18°C (Freezer)**



## Voltas Water Dispenser Minimagic Spring F

### Main Features

- **Product Dimension(WxDxH): 310 x 330 x 970**
- **Product Color: White**
- **Type: Floor Mounted**



**Voltas Water Cooler 40/80 FSS - 80 Litres**

**Main Features:**

- **Gross Volume: 80 L**
- **Product Dimension(WxDxH): 461 x 621 x 1311**
- **Food Grade Stainless Steel**



**Voltas Water Cooler 60/120 FSS - 120 Litres**

**Main Features:**

- **Gross Volume: 120 L**
- **Product Dimension(WxDxH): 566 x 746 x 1266**
- **Upto 40% Energy Efficient Compressor**

# ***ICE Cube Machine***





## EASY TO CLEAN AND MAINTAIN

Time and money can be saved by arriving quickly for servicing and cleaning.

A M series ice maker's door is simple to remove off and just requires the removal of two screws to provide easy access.

The food zone of M Series ice makers is lined with white plastic, which makes it simple to see what has to be cleaned.

Parts that require cleaning can be taken out without the use of tools. It is possible to remove the trough, floats, pump, distribution tube, and water shield by hand. In the food zone, bacteria and fungi that produce slime and emit odours are inhibited by optional clean Air packs.

MODELS	POWER/VOLTAGE	DIMENSION	ICE PRODUCTION 24 HOURS (KG)	REFRIGERANT	BIN MODEL	BIN CAPACITY	MACHINE WEIGHT
MD0500A	0	30 x 24,5 x 21,5	214	R-410A	D-400C	165kg	100,5kg
MD0700A	0	30 x 24,5 x 21,5	290	R-410A	D-570C	241kg	122kg
MD1000A	0	30 x 24,5 x 29,5	237	R-410A	D-570C	241kg	153kg
MD1400A	0	48 x 24,5 x 29,5	649	R-410A	D-970C	400kg	210,5kg





**ES60A**



**ES90A**



**ES0212A**

<b>Ice Production (kg)*</b>	28	50	90
<b>Bin Capacity</b>	14	14	36
<b>Width (cm)</b>	50	50	66
<b>Depth (cm)</b>	57	57	67
<b>Height (cm)</b>	79	79	98
<b>Power (Watts)</b>	450	477	594
<b>Refrigerant</b>	R-134A	R-134A	R-404A
<b>Weight</b>	40 kg	41 kg	54 kg

## Features & Benefit

- R-134 A or R-404 A, CFC-free refrigerant
- Easy access air filter designed for longer operation in greasy and dusty environments
- Storage bin liner is fabricated by rotational molding with polyethylene provides seamless and better insulation for longer ice storage
- CFC-free polyurethane foaming technology, better insulation for enhanced refrigeration efficiency while helping the environment
- Cleaning and sanitizing technology
- Apply the system of control board plus floor water & ice thickness probe, to improve the reliability and longevity of the ice machine.





## **Dynamic Preparation**

### **Food Preparation & Processing Equipment**





## CL 50 TABLE-TOP

### VEGETABLE PREPARATION MACHINES

Thanks to our range of Vegetable Preparation Machines, you can save hours of preparation in the kitchen: slicing, grating, chopping, shredding, julienne, brunoises, chip cutting, waffle cuts and even purees.

Induction motor	: ✓
Power	: 550 W
Voltage	: Single phase or Three phase
Speed	: 375 rpm
Feed hoppers	: Half moon hopper 2.2 L
	Cylindrical hopper Ø 58 mm and Ø 39 mm, Exactitube pusher - Included
Lid and bowl	: Metal
Motor base	: Composite material
Discs	: Not included

### CHOOSE YOUR PACK OF DISCS

Pack of 8 discs for Restaurants						
Slicers 2 mm - 5 mm	Grater 2 mm	Julienne 3x3 mm	Dicing Equipement 10x10x10 mm	French Fries Equipement 10x10x10 mm	Wall disc holder	D-Clean kit
Pack of 12 discs for Institutions						
Slicers 2 mm - 5 mm	Grater 2 mm - 5 mm	Julienne 3x3 mm - 4x4 mm	Dicing Equipement 10x10x10 mm - 20x20x20 mm	French Fries Equipement 10x10x10 mm	Wall disc holder x2	
Asia Pack of 7 discs						
Slicers 2 mm - 5 mm	Grater 2 mm	Julienne 2x2 mm - 3x3 mm	Dicing Equipement 10x10x10 mm	Wall disc holder	D-Clean kit	
Eastern Europe Pack of 5 discs						
Slicers 2 mm	Grater 2 mm	Julienne 4x4 mm	Dicing Equipement 10x10x10 mm			

### INNOVATION

### EXACTITUBE PUSHER

The secret of exclusive cuts!  
For slicing small and delicate ingredients such as chillis, gherkins, dry sausage, asparagus, spring onions, bananas, strawberries and grapes.



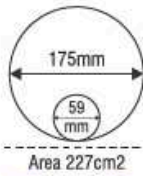

"Discover all the disk packs on page 49"



## CL 55 PUSHER FEED-HEAD

### VEGETABLE PREPARATION MACHINES

Especially designed for the preparation of large quantities of vegetables.

Induction motor	: ✓
Power	: 750 W / 1100W
Voltage	: Single phase or Three phase
Speed	: 375 rpm / 375rpm - 750rpm
Feed - heads	: Stainless steel automatic feed tube
	: Full moon pusher feed head 4,4 L
	: Cylindrical hoppers Ø 58 mm and Ø 39 mm,
	: Exactitube pusher - Included
Lid and bowl	: Metal
Motor base	: Stainless Steel
Mobile Stand	: Stainless Steel Equipped with 2 wheels and brake
Discs	: Not included



Pusher feed-head with built-in tube (surface area 227 sq.cm.)

### CHOOSE YOUR PACK OF DISCS

Pack of 8 discs for Restaurants						
Slicers 2 mm - 5 mm	Grater 2 mm	Julienne 3x3 mm	Dicing Equipement 10x10x10 mm	French Fries Equipment 10x10x10 mm	Wall disc holder	D-Clean kit
Pack of 12 discs for Institutions						
Slicers 2 mm - 5 mm	Grater 2 mm - 5 mm	Julienne 3x3 mm - 4x4 mm	Dicing Equipement 10x10x10 mm - 20x20x20 mm	French Fries Equipment 10x10x10 mm	Wall disc holder x2	
Asia Pack of 7 discs						
Slicers 2 mm - 5 mm	Grater 2 mm	Julienne 2x2 mm - 3x3 mm	Dicing Equipement 10x10x10 mm	Wall disc holder	D-Clean kit	
Eastern Europe Pack of 5 discs						
Slicers 2 mm	Grater 2 mm	Julienne 4x4 mm	Dicing Equipement 10x10x10 mm			

## CL 60 WORKSTATION

# FLOOR STANDING VEGETABLE PREPARATION MACHINES

Especially designed for the preparation of large quantities of vegetables.



### CL 60 WORKSTATION

### CL 60 PUSHER FEED-HEAD CL 60 V.V. PUSHER FEED-HEAD

Induction motor	: ✓	✓
Power	: 1500 W	1500 W
Voltage	: Single phase or Three phase	Single phase or Three phase
Speed	: 375rpm - 750rpm / 100rpm - 1000rpm	375rpm - 750rpm / 100rpm - 1000rpm
Feed - heads	Stainless steel automatic feed head	Stainless steel automatic feed head
	Full moon pusher feed head 4,9 L	Full moon pusher feed head 4,9 L
	Cylindrical hoppers Ø 58 mm and Ø 39 mm,	Cylindrical hoppers Ø 58 mm and Ø 39 mm,
	Exactitube pusher - Included	Exactitube pusher - Included
	4 tubes: 2 Ø 50mm tubes and 2 Ø 70mm tubes	
Lid and bowl	: Metal	Stainless Steel
Motor base	: Stainless Steel	Stainless Steel
Equipped with	: 1 adjustable foot for all floor types	1 adjustable foot for all floor types
	2 wheels 1 stainless steel container for cutting attachments,	2 wheels 1 stainless steel container for cutting attachments
Accessories	: Ergo mobile trolley with 3 GN1x1 gastronorm pans - Included	
	Wall disc holder with 1 GN1x1 gastronorm pan - Included	
	3 mm Potato Ricer Equipment - Included	
Discs	: MultiCut Pack of 16 discs - Included	Not Included



## 2 MACHINES IN ONE!

Space saving and multifunctional, the Robot-Coupe Food Processor is one of the Chef's greatest allies even in a very small kitchen.

## FOOD PROCESSORS CUTTERS & VEGETABLE SLICERS



MODELS	R 301 Ultra	R 402 V.V.	R 502 V.V.
Induction motor	: ✓	✓	✓
Power	: 650 W	1000 W	1500 W
Voltage	: Single phase	Single phase	Single phase
Speed	: 1500 rpm	300 to 3 500 rpm for cutter 300 to 1 000 rpm for vegetable slicer	
Pulse	: Yes	Yes	Yes
Cutter Bowl	: 3.7 L stainless steel	4.5 L stainless steel	5.9 L stainless steel
Blade	: Stainless steel smooth blade - Included		
Scraper arm	: No	Yes	Yes
Vegetable slicer	Half moon hopper 1,6 L		Half moon hopper 2,2 L
	Cylindrical hopper Ø 58 mm		Cylindrical hopper Ø 58 mm & Ø 39mm
			Exactitube pusher - Included
Discs	: Not Included		

## CHOOSE YOUR PACK OF DISCS

<b>Pack of 5 discs</b>			
Slicers 2 mm - 4 mm	Grater 2 mm	Julienne 4x4 mm - 8x8 mm	
<b>Asia Pack of 4 discs</b>			
Slicers 2 mm - 4 mm	Grater 2 mm	Julienne 2x2 mm	
<b>Asia Pack of 6 discs for R402 and R 402 V.V. only</b>			
Slicers 2 mm - 4 mm	Grater 2 mm	Julienne 2x2 mm	Dicing Equipment 10x10x10 mm
<b>Eastern Europe Pack of 3 discs</b>			
Slicers 2 mm	Grater 2 mm	Julienne 4x4 mm	



Area 104 cm<sup>2</sup>

"Discover all the disk packs on page 47"



Area 139 cm<sup>2</sup>

"Discover all the disk packs on page 49"

## THE MUST FOR PASTRY AND KITCHEN CHEFS!

With its bowl-base twin-blade assembly - a Robot-Coupe exclusivity - it is the Chef's ideal assistant. Whether you need small or large quantities, all your preparations can be made by just pressing a button: sauces, minced meat and fish, chopped onions, herbs and spices, ground nuts and chocolate, praline, kneading, etc.



### TABLE TOP CUTTER MIXERS

MODELS	R-3-1500	R-3-3000	R-4-1500
Induction motor	: ✓	✓	✓
Power	: 650 W	650 W	700 W
Voltage	: Single phase	Single phase	Single phase
Speed	: 1500 rpm	3000 rpm	1500 rpm
Pulse	: Yes	Yes	
Bowl	: 3,7 L stainless steel	3,7 L stainless steel	4,5 L stainless steel
Blade	: Stainless steel smooth blade - Included		

## THE SOLUTION FOR TEXTURE MODIFIED FOOD

The Blixer®, especially designed for the healthcare sector, turns raw products into texture modified foods. All foods, whether raw or cooked, sweet or savoury, whether entrees or mains, dessert or cheese, can be eaten by everyone at the table, even the most elderly.



### BLIXER®

MODELS	BLIXER 2	BLIXER 3	BLIXER 4-1V
Induction motor	: ✓	✓	✓
Power	: 700 W	750 W	900 W
Voltage	: Single phase	Single phase	Single phase
Speed	: 3000 rpm	3000 rpm	3000 rpm
Pulse	: Yes	Yes	Yes
Motor base	: Composite Material	Composite Material	Metal
Bowl	: 2,9 L stainless steel	3,7 L stainless steel	4,5 L stainless steel
Watertight Lid	: Yes	Yes	Yes
Blixer arm	: Yes	Yes	Yes
Blade	: Stainless steel fine serrated blade with removable cap Included		
Number of 200g portions	: Single portion	2-10	2-15

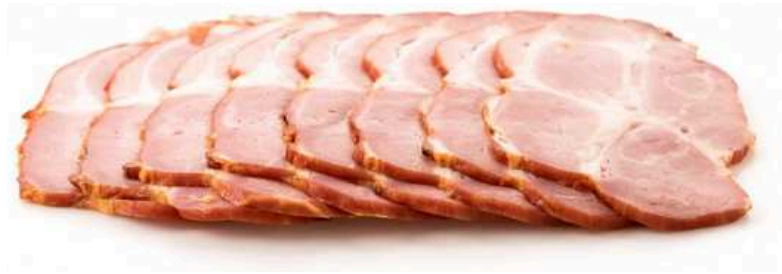

- Anodized cast aluminium alloy.
- Lat base for easy cleaning.
- Strong and silent-running asynchronous motor.
- Reliable poliV belt drive.
- Forged, hardened large thickness blades.
- Carriage running on self-lubricating bushes.
- Cast-in sharpener.
- Teflon coated or toothed blades available
- 25° blade inclination.

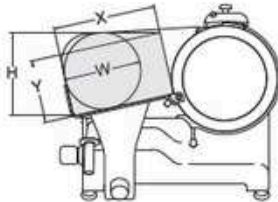
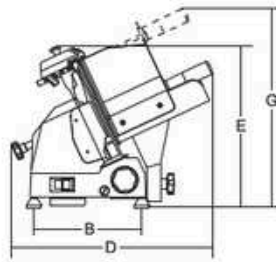
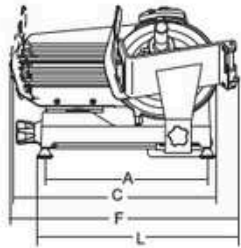

1. Hand guard
2. Underside motor protection plate
3. Without built-in sharpener 195-220

	Ø Blade	Motor	Cut thickness	Run of carriage	Hopper	A	B	C	D	E	F	G	L	X	Y	H	W	Net weight	Shipping	Gross weight
	mm/inch.	watt/HP	mm	mm	mm	mm	mm	mm	mm	mm	mm	mm	mm	mm	mm	mm	mm	kg	mm	kg
<b>Topaz 195</b>	195/8"	110/0,15	13	162	185x165	310	220	375	355	300	385	360	370	140	110	135	120	10,5	430x400 x370	12
<b>Topaz 220</b>	220/9"	145/0,20	13	245	200x220	380	250	440	410	330	550	400	450	200	130	145	140	13	600x500 x420	15
<b>Topaz 250 C</b>	250/10"	145/0,20	13	240	230x230	380	250	480	410	360	500	410	475	185	165	180	180	14	600x500 x420	16
<b>Topaz 275</b>	275/11"	145/0,20	13	235	220x225	412	255	520	410	370	525	455	505	200	190	205	205	16,5	600x500 x500	19
<b>Mirra 300 Y09</b>	300/12"	210/0,29	13	285	250x275													20,5	640x610 x510	23,5
<b>Palladio 350</b>	350/14"	370/0,50	23	310	305x270	465	340	680	575	455	710	530	580	270	225	275	250	37	760x640x700	46





# TC 12E-22E

## tritacarne meat grinders

- Costruzione in alluminio pressofuso lucidato
- Riduttore tritacarne a bagno d'olio
- Bocca ed elica tritacarne in ghisa trattata per uso alimentare, su richiesta anche in acciaio inox Aisi 304
- Piastra e coltello inox

### Versione CE con:

- Comandi IP54 con NVR

### Opzioni:

- Comandi con inversione
- TC 12: kit insacchitrice, imbuto  $\varnothing$  14-19-23
- TC 22: kit insacchitrice, imbuto  $\varnothing$  10-16-25

- Polished die-cast aluminum construction
- oil bath gearbox meat grinder
- Mouth and propeller mincer in untreated cast iron for food, on request in Aisi 304 stainless steel
- S7steel plate and knife

### CE version with:

- IP54 protection rated controls and NVR device

### Optionals:

- Reverse
- TC 12: stuffer kit, funnels  $\varnothing$  14-19-23
- TC 22: stuffer kit, funnels  $\varnothing$  10-16-25

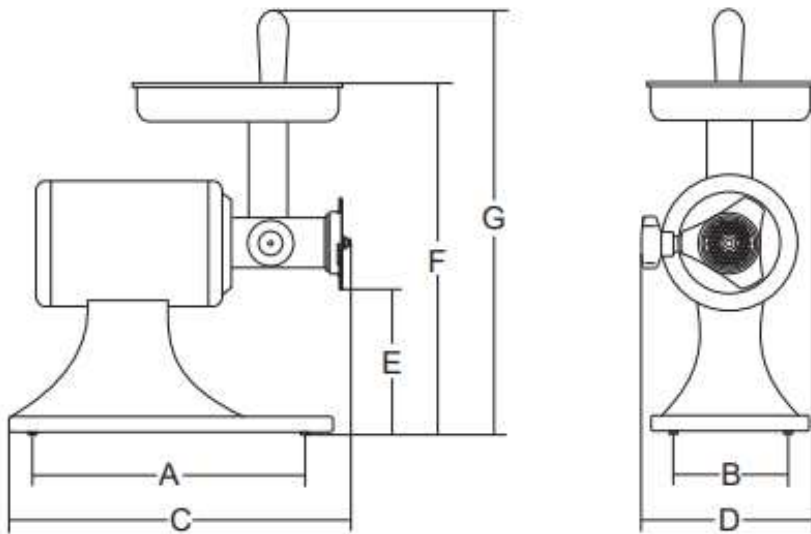

watt/Hp

1ph/3ph

Kg/10 min.

$\varnothing$  mm

mm

mm

mm

mm

mm

mm

mm

mm

kg

mm

kg

TC 12 E	735/1	1ph/3ph	25	4.5	225	185	430	215	140	445	520	18	320x460x470	20
TC 22 E	800/1.2	1ph/3ph	33	4.5	225	185	440	215	135	445	520	21	320x460x470	23

# TC 8 VEGAS

tritacarne  
meat grinders



- Robusta struttura in alluminio anodizzato
- Corpo in alluminio anodizzato e fianchi in ABS antiurto o in acciaio inox
- Motore ventilato
- Riduttore tritacarne ermetico con ingranaggi a bagno d'olio
- Ingranaggi elicoidali temperati e rettificati
- Bocca ed elica tritacarne in lega di alluminio alimentare brillantata
- Piastra e coltello inox
- Pratico cassetto per piastra e coltello
- Inversione di marcia di serie
- Comandi IP54 con NVR.

- *Sturdy anodized aluminum frame*
- *Anodized aluminum body and ABS shockproof or s/steel sides*
- *Ventilated motor*
- *Hermetic meat grinder gearbox with oil bath gears*
- *hardened and ground helical gears*
- *Mouth and meat grinder alloy blade of alums*
- *S/steel plate and knife*
- *Compartment for knife and plate*
- *Reverse shuttle fitted as standard*
- *IP54 protection rated controls and NVR device*

					A	B	C	D	E	F	G			
	wait/tp		Kg/h.	ø mm	mm	mm	mm	mm	mm	mm	mm	kg	mm	kg
TC 8 Vegas	250/0.34	1ph	70	6	205	170	335	300	65	360	410	10	560x400x350	12
TC 8 Vegas FX	250/0.34	1ph	70	6	247	166	365	304	90	334	410	10	560x400x350	12

## BONE SAWS



- ➔ Simple and sturdy machines that are safe and easy to use.
- ➔ Stand-alone structure made out of cast anodized aluminium, shiny, hygienic and rustproof.
- ➔ Features a counter, meat pusher and serving slicer in stainless steel A/SI 304
- ➔ 24V controls with safety micro-switch on door, redundant ECU and motor brake (EC).
- ➔ Utmost simplicity and accuracy when horizontally and vertically adjusting the upper pulley.
- ➔ Maximum blade adhesion to the pulley, thanks to the semi-curved shape of the pulleys and ideal adjustment.
- ➔ Airtight bearings on upper pulley.
- ➔ Powerful asynchronous and ventilated 4-pole motors protected by sealing oil sump
- ➔ Group washing cycle
- ➔ The machines use tempered 16 mm blades to shred bone, frozen or fresh.

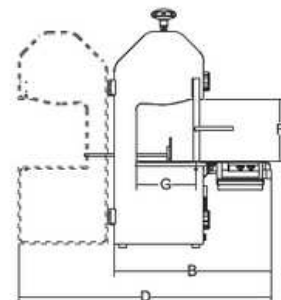
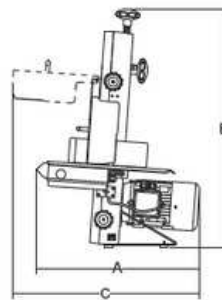

	Blade length	Motor	Pulley	Working surface	A	B	C	D	E	F	G	Net weight	Shipping	Gross weight
	mm	Hp/lr.p.m.	mm	mm	mm	mm	mm	mm	mm	mm	mm	Kg	mm	kg
<b>SO 1550 F3</b>	1550	1ph 1/1400 - 3ph 1,5/1400	210	400x420	530	510	606	822	778	215	195	32	720x570x1200	44
<b>SO 1650 F3</b>	1650	1ph 1/1400 - 3ph 1,5/1400	210	430x475	530	600	640	950	915	250	200	39	720x570x1200	51
<b>SO 1840 F3</b>	1840	1ph 1/1400 - 3ph 1,5/1400	250	430x475	530	600	640	950	915	250	240	40	720x570x1200	52
<b>SO 2020 Inox</b>	2020	900	250	480x600								61	760x640x1430	73



*Slices discs DF*

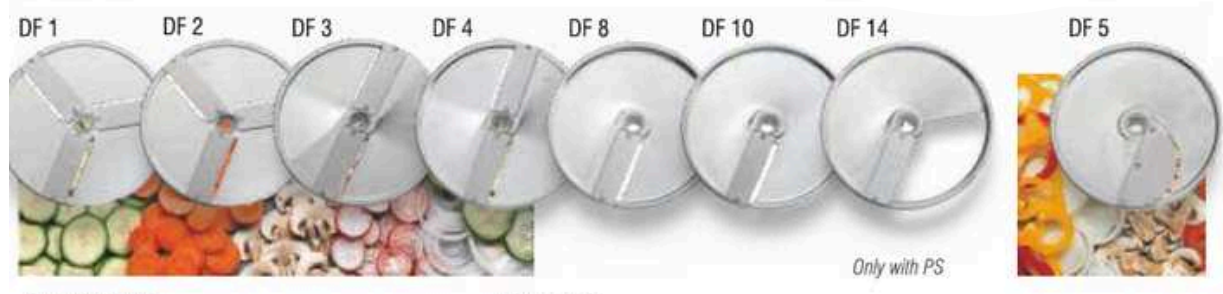

*Discs DQ sticks*



*Dicing discs*



*Discs for shredding DT*



*PS discs only use with DF*

*Grating discs*

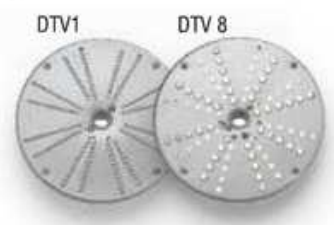

*Aluminium feed hopper lid with side opening*



*Chute for continuous product ejection, with safety microswitch.*



*PS dicing disc cleaner*



*Discs holder*

## TS-678



- Power: 2.2KW
- Voltage: 200-230V 50HZ
- Size: 316X316 mm
- Size Of Control Box: 128x42 mm

- Power: 3.4KW
- Voltage: 200-230V 50HZ
- Size: 735x435x65 mm
- Cutout Size: 680x400 mm

## TS34C01



## TM-767



- Capacity: 2 Ltrs
- Voltage: 220-240V~ / 50-60Hz
- Power (W): 2238
- 3HP High Efficient Motor
- Function: Variable Speed Control
- Dimensions: 20x24x51cm



## TM-800A



- Capacity (l): 1.5
- Voltage: 220V
- Power (W): 2238
- 3HP Motor
- Function: Variable Speed
- Controls Type: Touchpad
- Dimensions: (L)20x(W)24x(H)42cm

## TM-800AQ OMNI-Q



- Capacity (l): 1.5
- Voltage: 220V
- Power (W): 2238
- 3HP Motor
- Function: Variable Speed
- Controls Type: Touchpad
- Dimensions: (L)30x(W)27x(H)46cm



## GES 10



**Waffle Maker**

- Voltage: 230V
- Power: 1.6KW
- Capacity: 40 Waffles/Hr
- Squares : 20 x 25 mm,
- Waffle Size: 100x170x22 mm
- Dimensions: 305x510x310 mm



- Voltage: 230V
- Power: 3KW
- Capacity: 48 Panini/Hr
- Cooking Surface: 360X240
- Dimensions: 380X460x280



## PANINI



## SEM 600 PDS



**SALAMANDER**

- Voltage: 230V, Power: 3KW
- 3 Sides Open
- Working Height: Min 90/Max 245mm.
- Cooking Surface: 495x375 mm
- Dimensions: 600x640x590 mm

## GR 40 E



**SHAWARMA MACHINE**

- Voltage: 230V, Power: 3.6KW
- 3 Incoloy Heating Elements
- Capacity Meat: 15KG
- Spit Height: 400mm
- Dimensions: 580x660x690 mm

## FD 50



**FRYER**

- Voltage: 230V, Power: 3.2KW
- Volume: 5 Ltrs
- Capacity (French Fries): 1.5KG
- Output (French Fries): 8KG/Hr
- Basket Size: 140x260x100mm
- Dimensions: 215x425x320mm

- Voltage: 230V
- Power: 2KW
- Capacity: 96 Hamburgers Or Steaks/Hr
- Cooking Surface: 260X240
- Dimensions: 280X460x280



**SAVOYE**





### TECHNICAL DATA

MODEL	Pratica E1	Pratica E2
Dimensions(WxHxD)	339x500x475 mm	585x500x475 mm
Weight	34 kg	47 kg
Display	No	No
Number of buttons	5	5
Steam boiler capacity	4 L	11 L
Voltage	220 - 240 V 50/60 Hz	220 - 240 V 50/60 Hz
Watts 1	850 W	3150 W



### TECHNICAL DATA MANUAL / AUTOMATIC GRINDER

MODEL	X010
Assembled (HxWxL) mm	650 x 280 x 390
Weight	14Kg
Grinding stones diameter	64mm
Bean Hopper capacity	1.2Kg.
Grinding capacity	6-8Kg/hour
Dispenser capacity	240gr. (powder coffee)
Dispensing capacity	5-9gr/dose
Electric Power	370watt

### MAIN FEATURES

- Durable and unbreakable hopper .
- Food grade hardened tooling steel grindstones
- Stepless adjustment for accurate grinding
- 4 optional colors: Black Red Silver and white
- Manual or Automatic control.



### TECHNICAL DATA

MODEL	Mya Ultra
Average Daily Production	400 cups
Dimensions(WxHxD)	290x814x592 mm
Weight	42 kg
User interface	10" touch screen
Spout clearance	90 - 195 mm
Bean hopper capacity	1,3 kg
Instant canisters	-
Coffee boiler capacity	Heat exchanger
Steam boiler capacity	4 l
Group capacity	10 - 20 g (M - Brew XL)
Communication protocol	MDB, Executive
Voltage	220 - 240 V 50/60 Hz





White



Black



**Dimensions**  
W368 X D550 XH 585 mm

### MAIN FEATURES

Coffee boiler capacity	0.6 l
Coffee hopper capacity	0.6 Kg
Instant container capacity	0.8 l
Internal tank capacity	4.0 l
N° of grinders	1-2
N° of mixer	0-2
N° of cups per minute	2 Espresso 1 Cappuccino
Weights	Net 25 Kg Gross 30 Kg

### ELECTRICITY SUPPLY

100-120 V 1+N 50/60 Hz 1.400 W
220-240 V 1+N 50/60 Hz 1.700 W

### WATER SUPPLY

- Internal water tank
- Water mains connection
- Jolly: water tank + mains connection

Black



### ADD-ON UNITS

Fridge with digital temperature

Capacity	7.5 l
Electricity supply	220/230V 50/60Hz
Net weight	14 Kg
Cup warmer	Optional

**Dimensions**  
W 225 X D 462 X H 392 mm





**FA-520B**  
Power : ½HP  
Size : 2100x850x1100mm  
Conveyor Size : 515x2000mm



**FA-450A**  
Power : ½HP  
Size : 1800x760x600mm  
Conveyor Size : 430x1700mm



**FA-520A**  
Power : ½HP  
Size : 1800x850x600mm  
Conveyor Size : 515x1700mm



HAseries / SP-502A

**Model**

### Motor

750W, grease packed ball bearing, air-cooled, 110V/60Hz, 220V/50Hz, Single phase

### Controls

Spar Mixer controls are side-mounted to give easy access in cramped kitchen environments.

### Attachment Hub

#10 Attachment Hub can use Pasta Kit, Meat Mincer and Vegetable Prep Attachment.

### Transmission

The unique design yields high-torque mixing power while avoiding the high cost encountered repairing direct-drive transmission components.

### Speeds(Agitator rpm)

1st gear 71 rpm    6rd gear 306rpm  
2nd gear 120rpm    7rd gear 355 rpm  
3rd gear 169rpm    8rd gear 401 rpm  
4rd gear 210rpm    9rd gear 443 rpm  
5rd gear 253rpm    10rd gear 490 rpm

### Bowls and Agitators

Standard equipment includes a 5Litres high quality stainless steel bowl, dough hook, flat beater, and whip. A sturdy hand lever on the body column raises and lowers the bowl as well as locking in place at the top and bottom positions.

### Finish

Powder Coating

### Shipping Information

N.W. 15.25 kgs  
G.W. 17.45 kgs

### Size (L x W x H)

345mm x 389mm x 434mm



MAseries / SP-502

### Motor

750W, grease packed ball bearing, air-cooled, 110V/60Hz, 220V/50Hz, Single phase

### Controls

Spar Mixer controls are side-mounted to give easy access in cramped kitchen environments

### Attachment Hub

#10 Attachment Hub can use Pasta Kit, Meat Mincer and Vegetable Prep Attachment.

### Transmission

The unique design yields high-torque mixing power while avoiding the high cost encountered repairing direct-drive transmission components.

### Speeds(Agitator rpm)

1st gear 71 rpm    6rd gear 306rpm  
2nd gear 120rpm    7rd gear 355 rpm  
3rd gear 169rpm    8rd gear 401 rpm  
4rd gear 210rpm    9rd gear 443 rpm  
5rd gear 253rpm    10rd gear 490 rpm

### Bowls and Agitators

Standard equipment includes a 5Litres high quality stainless steel bowl, dough hook, flat beater, and whip. A sturdy hand lever on the body column raises and lowers the bowl as well as locking in place at the top and bottom positions.

### Finish

Powder Coating

### Shipping Information

N.W. 15.07 kgs  
G.W. 17.27 kgs

### Size (L x W x H)

345mm x 389mm x 434mm

# Juicer

**SANTOS**



**SANTOS CITRUS JUICER NO. 11**

- Single Phase: 220-240V-50/60Hz
- Power: 130W - CE
- Speed: 1500 rpm (50 Hz)
- Output: 30 Liters Of Juice
- Per Hour (8 Gallons)
- Dimensions: 230X300X350



**SANTOS CITRUS JUICER NO. 10**

- Single Phase: 220-240V-50/60Hz
- Power: 230W - CE
- Speed: 1500 rpm (50 Hz)
- Output: 30 Liters Of Juice
- Dimensions: 200X300X380



- Single Phase: 220-240V-50/60Hz
- Power: 650 W
- Speed: 5 to 80 rpm
- Pulp Container: 4 Litres
- Output: 60 l/h
- Dimensions: 412X236X642mm



**SANTOS COLD PRESS JUICER NO. 65**

# *Value Line*

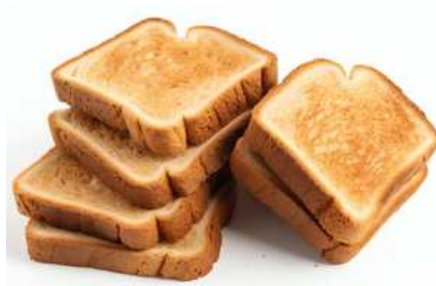

## RB-110ES

- Voltage: 220V
- Power: 3.2KW
- Capacity: 1 Deck / 1 Tray
- Weight: 55Kg
- Chamber Size: 640x455x180
- Dimension: 925X570X430mm



## RB-110GS

- Voltage: 220 V
- Power: 100 W
- Capacity: 1 DACK /1 TRAY
- Chamber Size: 670X530X180 mm
- Dimension: 1050X660X490 mm

## EP-1P



- Voltage: 220V
- Power: 2KW
- Capacity: 1 Deck
- Weight: 24Kg
- Chamber Size: 400x400x1
- Dimension: 560X570X280mm

## EP-2P



- Voltage: 220V
- Power: 3KW
- Capacity: 2 Deck
- Weight: 33Kg
- Chamber Size: 400x400x2
- Dimension: 560X570X440mm



## HX-1



- Voltage: 220V
- Power: 6.3KW
- Working Area: 560x385
- Weight: 47Kg
- Dimension: 1080/1380X555X420



## CONVEYOR PIZZA OVEN

## EF-4SC

- Voltage: 220V/50Hz/1Ph
- Power: 2000W
- Capacity: 4 Ltr
- Weight: 5Kg
- Dimension: 265X385X320mm

## EF-8SC

- Voltage: 220V/50Hz/1Ph
- Power: 2800W
- Capacity: 8 Ltr
- Weight: 6.2Kg
- Dimension: 310X410X340mm



**SINGLE TANK ELECTRIC FRYER**

## EF-6SC

- Voltage: 220V/50Hz/1Ph
- Power: 2500W
- Capacity: 6 Ltr
- Weight: 5.6Kg
- Dimension: 310X410X290mm

## EF-11SC

- Voltage: 220V/50Hz/1Ph
- Power: 3200W
- Capacity: 11 Ltr
- Weight: 11.4Kg
- Dimension: 370X440X340mm

## EF-4TC

- Voltage: 220V/50Hz/1Ph
- Power: 2x2000W
- Capacity: 4x2 Ltr
- Weight: 9.2Kg
- Dimension: 490X385X320mm



**DOUBLE TANK ELECTRIC FRYER**

## EF-6TC

- Voltage: 220V/50Hz/1Ph
- Power: 2x2500W
- Capacity: 6x2 Ltr
- Weight: 10.2Kg
- Dimension: 590X385X220mm

## EF-8TC

- Voltage: 220V/50Hz/1Ph
- Power: 2x2800W
- Capacity: 8x2 Ltr
- Weight: 11Kg
- Dimension: 592X410X340mm

## EF-11TC

- Voltage: 220V/50Hz/1Ph
- Power: 2x3200W
- Capacity: 11x2 Ltr
- Weight: 15Kg
- Dimension: 725X440X345mm



# ELECTRIC FRYER

- Voltage: 220V/50Hz/1Ph
- Power: 2500W
- Capacity: 6 Ltr
- Weight: 4.5Kg
- Dimension: 275X430X290mm

**EF-6L**



**EF-6LX2**



- Voltage: 220V/50Hz/1Ph
- Power: 2x2500W
- Capacity: 6x2 Ltr
- Weight: 9Kg
- Dimension: 550X430X290mm



- LPG Gas Operated
- Capacity: 8 Ltrs
- Weight: 22Kg
- Dimension: 300X600X550mm

**GF-971**



# ELECTRIC TOASTER

**4-ATS**



**4 SLICE SLOT TOASTER**

- Voltage: 220V/50Hz/1Ph
- Power: 2240W
- Capacity: 4 Slice
- Weight: 6Kg
- Dimension: 370X210X225mm



- Voltage: 220V/50Hz/1Ph
- Power: 3240W
- Capacity: 6 Slice
- Weight: 8Kg
- Dimension: 460X210X225mm

**6-ATS**



**6 SLICE SLOT TOASTER**



# CONVEYOR TOASTER



## TT-300

- Voltage: 220V/50Hz/1Ph
- Power: 2200W
- Capacity: 300-350 Slice/Hr
- Weight: 16Kg
- Dimension: 560X385X380mm

## TT-150

- Voltage: 220V/50Hz/1Ph
- Power: 1300W
- Capacity: 150-180 Slice/Hr
- Weight: 14Kg
- Dimension: 510X360X380mm

## TT-400

- Voltage: 220V/50Hz/1Ph
- Power: 2600W
- Capacity: 450-500 Slice/Hr
- Weight: 30.5Kg
- Dimension: 510X540X380mm

# SANDWICH GRILLER



## GH-811A

- Voltage: 220V
- Power: 1.8KW
- Upper Grill: 216x215
- Lower Grill: 240X280
- Temperature: 300°C
- Head: 1
- Dimension: 350X400X210mm

## GH-811E

- Voltage: 220V
- Power: 2.2KW
- Upper Grill: 335x218
- Lower Grill: 365X277
- Temperature: 300°C
- Head: 1 Jumbo
- Dimension: 425X400X210mm

SINGLE HEAD SANDWICH GRILLER

## GH-813A



DOUBLE HEAD SANDWICH GRILLER

- Voltage: 220V
- Power: 1.8+1.8KW
- Upper Grill: 216x215
- Lower Grill: 500X280
- Temperature: 300°C
- Head: 2
- Dimension: 580X400X210mm



# TABLE TOP GRIDDLE PLATE



### GH-818



- Full Smooth
- Voltage: 220V
- Power: 3KW
- Dimension: 550X430X240mm

### GH-820



- Full Smooth
- Voltage: 220V
- Power: 4.4KW
- Dimension: 730X470X240mm

### GH-822



- 2/3 Smooth And 1/3 Ribbed
- Voltage: 220V
- Power: 4.4KW
- Dimension: 730X470X240mm

# WAFFLE MACHINE

### RW-1



### ROTATING WAFFLE MACHINE

- VOLTS: 220V/50HZ
- POWER: 1.2 KW
- SIZE: 250\*380\*300mm



### UWB-1



### TABLE TOP WAFFLE MACHINE

- Voltage: 220V
- Power: 1KW
- Temperature: 0-300°C
- Waffle Plate: Dia 20cm
- Dimension: 250X360X270mm

# WAFFLE MACHINE

- Voltage: 220V
- Power: 1.6KW
- Temperature: 0-300°C
- Dimension: 282X380X230mm



**SQUARE WAFFLE MACHINE**

**UWB-2**



- Voltage: 220V
- Power: 1.2KW
- Temperature: 0-300°C
- Waffle Plate: Dia 20cm
- Dimension: 500X360X360mm

**TABLE TOP WAFFLE MACHINE**

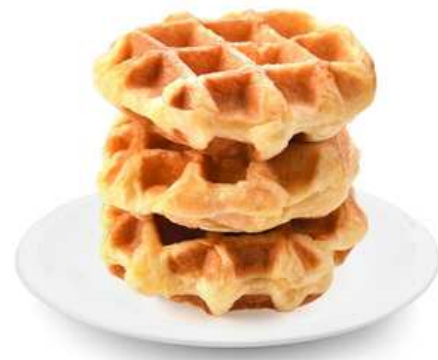

**ZU-1**

- Voltage: 220V
- Power: 1KW
- Temperature: 0-300°C
- Dia: 22cm
- Dimension: 282X380X236mm



**TABLE TOP CONE BAKER**

**FWH-2P**



**DISPLAY WARMER**

- Voltage: 220V/50Hz/1Ph
- Power: 1200W
- Weight: 28Kg
- Dimension: 660X500X620mm

**FWH-60**



**DISPLAY WARMER**

- Voltage: 220V/50Hz/1Ph
- Power: 1840W
- Weight: 33Kg
- Dimension: 660X480X610mm

**PW-14**



**FOOD DISPLAY STEAMER**

- Voltage: 220-240V
- Power: 0.85KW
- Weight: 38Kg
- Dimension: 550X450X777mm

**DS-500H**



**FOOD DISPLAY STEAMER**

- Voltage: 220-240V
- Power: 0.9KW
- Weight: 24Kg
- Dimension: 380X400X745mm

# ELECTRIC SALAMANDER

HOT LINE



**EB-450**

- Voltage: 220V
- Power: 2800W
- Tray/Grid: 440x320
- Temperature: 300°C
- Weight: 39Kg
- Dimension: 450X450X500mm

**EB-600**

- Voltage: 220V
- Power: 4000W
- Tray/Grid: 585x320
- Temperature: 300°C
- Weight: 49Kg
- Dimension: 600X450X500mm

- Voltage: 220V
- Power: 2000W
- Weight: 11Kg
- Dimension: 610X310X280mm



**AT-936**

**AT-937**

- Voltage: 220V
- Power: 4000W
- Weight: 24Kg
- Dimension: 790X450X490mm



**AT-938**

- Voltage: 220V
- Power: 2200W
- Weight: 16Kg
- Dimension: 580X390X380mm

**DE-01**

- Voltage: 220V/50Hz/1Ph
- Power: 3000W
- Weight: 23Kg
- Dimension: 450X470X230mm



**CREPE MACHINE**

**VS-550**



**VEGETABLE SLICER**

- Voltage: 230V/50Hz/1Ph
- Power: 550W
- Weight: 22Kg
- Dimension: 560X290X560



## EPC-4A



**ELECTRIC PASTA COOKER**

- Voltage: 220-240V/50-60Hz
- Power: 4KW
- Temperature: 50-110°C
- Weight: 12.8Kg
- Dimension: 450X530X450mm

**HOT LINE**



**ERC-23L**



- Voltage: 220V/50Hz
- Power: 3KW
- Capacity: 23L



**ELECTRIC RICE COOKER**

## TS-6000B



**SOUP KETTLE**

- Voltage: 220V/50Hz/1Ph
- Power: 600W
- Weight: 4.5Kg
- Dimension: 345X360mm



## PO-1120

- Voltage: 220V
- Power: 6.3Kw
- Weight: 47Kg
- Working Area: 560x385
- Dimension: 1080/1380x555X420mm



**PIZZA CONVEYOR OVEN**





### SXC-12E

- Voltage: 220V
- Power: 0.55KW
- Capacity: 120Kg/Hr
- Weight: 27Kg
- Dimension: 400X190X410mm

### SXC-22E

- Voltage: 220V
- Power: 0.75KW
- Capacity: 220Kg/Hr
- Weight: 35Kg
- Dimension: 410X240X450mm

### MEAT GRINDER



- Voltage: 110/220V/50-60Hz
- Power: 1.1KW
- Wheel Diameter: 210mm
- Band Saw's Speed (M/S): 15
- Table Size (CM): 61x53
- Gross Weight: 65Kg
- Package Size (CM): 63X51X96.5

### J-210



### BONE SAW MACHINE

### MSSL220



- Speed Blade: 300 RPM
- Diameter Blade: Ø 220 mm
- Net weight: 14 kg
- Dimensions: 450x280x320 mm
- 220-230V/50Hz/1Phase

### MEAT SLICER



# PLATE WARMER

HOT LINE

**DR-1**



**PLATE WARMER**

- Voltage: 220-240V/50-60Hz
- Power: 0.4KW
- Tube: 1
- Weight: 31Kg
- Dimensions: 455X555X925mm

**DR-2**



**PLATE WARMER**

- Voltage: 220-240V/50-60Hz
- Power: 0.8KW
- Tube: 2
- Weight: 48Kg
- Dimensions: 455X950X925mm

**DR-3**



**PLATE WARMER**

- Voltage: 220V
- Power: 400W
- Tube: 1
- Weight: 19Kg
- DIA: 405X725mm





**SY-8**



**POTATO PEELER**

- Voltage: 220V/50Hz
- Power: 0.37KW
- Capacity: 8Kg
- Dimension: 430X430X725mm

**HOT LINE**

**HD-05**



**HOT DOG ROLLER**

- Voltage: 220V/50-60Hz
- Power: 1000W
- Weight: 8Kg
- Dimension: 560X255X190



**HDS-03**



**HOT DOG STEAMER**

- Voltage: 220V/50Hz
- Power: 0.8KW
- Dimension: 467x300x385 mm
- Net Weight: 9Kg

**A031**



**HEATING / DECORATIVE LAMP**

- Voltage: 220V
- Power: 250W
- Diameter: 175mm
- Adjustable Height: 0.6~1.8mm

**BC110-100**



**DIGITAL WATER BOILER**

- VOLTS: 220~240V/50Hz
- POWER: 2500W
- TIMING CLOCK: V
- MATERIAL: S/S
- CAPACITY: 6 LTR.
- HOUR WATER TAKEOUT: 22 LTR.
- DIMENSIONS: 190X240X520 MM



## HW-TP3.5A-02

- Dimension(mm): 350\*450\*150
- Fire Adjustment: 9 power levels
- Watt: 3,500W
- Voltage: AC 220V, 50Hz
- Display mode: LED
- Half-bridge technology when the cooker is in low -power, will continue to be heated.
- HW-3.5KW-F main board

## HW-TP5A-02

- Dimension(mm): 380\*500\*200
- Fire Adjustment: 9 power levels
- Watt: 5000W
- Voltage: AC 220V, 50Hz
- Display Mode: LED
- Half-bridge technology when the cooker is in low -power, Will continue to be heated Continuous working 12 hours.

TABLE TOP INDUCTION PLATE

- Dimension(mm): 340\*340\*100
- Fire adjustment: 9 power levels
- Watt: 3500W
- Voltage: AC 220V, 50Hz
- Display mode: LED

## HW-QP3.5-04D



TABLE TOP INDUCTION PLATE



## HK-BS-31



- Voltage: 220V
- Power: 0.25KW
- Blade Qty: 31Pcs
- Bread Thick: 12mm
- Weight: 71KG
- Dimension: 650x740x780

**BREAD SLICER**

## JDR520B

- Voltage: 220/1Ph
- Power: 0.55KW
- Roller Range: 1~35 mm
- Roller Diameter (mm): 89
- Conveyor Belt Size: 500\*1980 mm
- Maximum Roll Weight: 5Kg
- Weight: 150KG
- Dimension: 2400\*920\*650 mm



**TABLE TOP DOUGH SHEETER**

## JDR520



- Voltage: 220/1Ph
- Power: 0.55KW
- Roller Range: 1~35 mm
- Roller Diameter (mm): 89
- Maximum Roll Weight: 5KG,
- Weight: 190KG
- Dimension: 2350\*870\*1230
- Conveyor Belt Size(mm): 500\*1980

**FLOOR TYPE DOUGH SHEETER**

- Voltage: 220/1Ph
- Power: 0.75Kw
- Roller Range: 1~35 mm
- Roller Diameter (mm): 73
- Maximum Roll Weight: 6.5Kg
- Net Weight: 260Kg
- Dimension: 3480\*1110\*1280
- Conveyor Belt Size(mm): 610\*2800

## JDR630



**FLOOR TYPE DOUGH SHEETER**

## NFQ-380

- Voltage: 220-380V
- Power: 0.8KW/1.13KW
- Plate Size: 380mm
- Weight: 237KG
- Yield: 10-1000g
- Dimension: 1450x670x1100



## BREAD MOULDER

## SPIRAL MIXER



### HS30S

- Voltage: 380V
- Power: 1.3KW/1.7KW
- Speed (R/Min): 15/23/150/230
- Volume: 28L
- Capacity: 12.5KG
- Weight: 167KG
- Dimension: 850x430x940

### HS40S

- Voltage: 380V
- Power: 1.2KW/1.8KW
- Speed (R/Min): 12/24/120/240
- Volume: 45L
- Capacity: 20KG
- Weight: 256KG
- Dimension: 900x500x1180

### HS50S

- Voltage: 380V
- Power: 2.8KW/3.6KW
- Speed (R/Min): 12/24/120/240
- Volume: 66L
- Capacity: 25KG
- Weight: 275KG
- Dimension: 1030x580x1230

# SPIRAL MIXER

## HS20



- Voltage: 220V
- Power: 1.1KW
- Speed (R/Min): 207
- Volume: 20L
- Capacity: 6KG
- Weight: 85KG
- Dimension: 668x409x854

## HS140S



- Voltage: 380V
- Power: 2.8KW/5.6KW
- Speed (R/Min): 22/110/220
- Volume: 140L
- Capacity: 50KG
- Weight: 640KG
- Dimension: 1200x735x1370

# PLANETARY MIXER

## B-7L



- Voltage: 220V
- Power: 370W
- Capacity: 7L
- Flour Capacity: 0.5KG
- Net Weight: 17KG
- Dimension: 390\*225\*420mm

- Voltage: 220V
- Power: 2KW
- Capacity: 40L
- Flour Capacity: 6-8KG
- Net Weight: 130KG
- Dimension: 580\*630\*1050mm

## B-40LB



# PLANETARY MIXER



## B5S

- Voltage: 220V
- Power: 0.5 W
- Speed (R/Min): 0-1000r/min
- Volume: 5.5L
- Capacity: 500G
- Egg Mixing Quantity: 500g
- Weight: 13KG
- Dimension: 380X240X375 mm

## B7S

- Size: 380\*240\*405MM
- Voltage: 110V/220-240V /50-60Hz
- Power: 0.5 W
- Capacity: 7.5L
- Dough Mixing
- Quantity:700g
- Egg Mixing Quantity: 700g
- Speed: 0-1000r/min
- Weight: 13.3Kg



## KM10LB

- Voltage: 220V/50Hz
- Power: 750 W
- Speed (R/Min): 50/100/194
- Volume: 10L
- Capacity: 2.5KG
- Weight: 62KG
- Dimension: 400x520x720

## KM20LB

- Voltage: 220V/50Hz
- Power: 1000 W
- Speed (R/Min): 48/95/186
- Volume: 20L
- Capacity: 5KG
- Weight: 79KG
- Dimension: 460x620x840

## KM30LB

- Voltage: 220V/50Hz
- Power: 1500 W
- Speed (R/Min): 49/98/191
- Volume: 30L
- Capacity: 6.5KG
- Weight: 80KG
- Dimension: 470x650x840



## B40FA

- Voltage: 220-380V
- Power: 1.5KW
- Speed (R/Min): 120/187/520
- Volume: 35L
- Capacity: 9KG
- Weight: 210KG
- Dimension: 650x620x1120

## B60A

- Voltage: 380V
- Power: 2.2KW
- Speed (R/Min): 82/155/326
- Volume: 60L
- Capacity: 25KG
- Weight: 395KG
- Dimension: 910x730x1460



# PLANETARY MIXER

## B-60LB



- Voltage: 220V
- Power: 3KW
- Capacity: 60L
- Flour Capacity: 8-11KG
- Net Weight: 305KG
- Dimension: 610\*650\*1360mm

## HS-10L

- Voltage: 220V
- Power: 750W
- Capacity: 10L
- Flour Capacity: 5KG
- Net Weight: 60KG
- Dimension: 540\*315\*650mm

## HS-20L

- Voltage: 220V
- Power: 1.5KW
- Capacity: 20L
- Flour Capacity: 8KG
- Net Weight: 85KG
- Dimension: 700\*500\*770mm



## HS-30L

- Voltage: 220V
- Power: 1.5KW
- Capacity: 30L
- Flour Capacity: 12KG
- Net Weight: 102KG
- Dimension: 770\*550\*850mm

## HS-40L

- Voltage: 220V
- Power: 1.5KW
- Capacity: 40L
- Flour Capacity: 15KG
- Net Weight: 105KG
- Dimension: 770\*550\*850mm

## HS-50L

- Voltage: 220V
- Power: 2.2KW
- Capacity: 50L
- Flour Capacity: 20KG
- Net Weight: 165KG
- Dimension: 880\*530\*920mm

## HS-60L

- Voltage: 220V
- Power: 2.5KW
- Capacity: 60L
- Flour Capacity: 25KG
- Net Weight: 166KG
- Dimension: 880\*530\*920mm

# ELECTRIC BAKERY OVEN



## RB-110E

- Voltage: 220V
- Power: 3.2KW
- Capacity: 1 Deck/ 1 Tray
- Tray Suitable: 600X400 mm
- Weight: 68 KG
- Chamber Size: 640X455X180
- Dimension: 925X570X430

## RB-120E

- Voltage: 220-380V
- Power: 6.6KW
- Capacity: 1 Deck/ 2 Tray
- Tray Suitable: 600X400 mm
- Weight: 75 KG
- Chamber Size: 860X670X220
- Dimension: 1260X805X535

## RB-130E

- Voltage: 380V
- Power: 9KW
- Capacity: 1 Deck/ 3 Tray
- Tray Suitable: 600X400 mm
- Weight: 105 KG
- Chamber Size: 1300X670X220X3
- Dimension: 1770X840X615

### RB-240E



- Voltage: 380V
- Power: 13.2KW
- Capacity: 2 Deck / 4 Tray
- Tray Suitable: 600x400mm
- Weight: 135KG
- Chamber Size: 860x670x220x2
- Dimension: 1260x805x1100

### RB-260E

- Voltage: 380V
- Power: 18KW
- Capacity: 2 Deck / 6 Tray
- Tray Suitable: 600x400mm
- Weight: 190KG
- Chamber Size: 1300x670x220x6
- Dimension: 1700x805x1100

### RB-360E



- Voltage: 380V
- Power: 19.8KW
- Capacity: 3 Deck / 6 Tray
- Tray Suitable: 600x400mm
- Weight: 206KG
- Chamber Size: 860x670x220x3
- Dimension: 1260x805x1515

### RB-390E

- Voltage: 380V
- Power: 25.2KW
- Capacity: 3 Deck / 9 Tray
- Tray Suitable: 600x400mm
- Weight: 290KG
- Chamber Size: 1300x670x220x9
- Dimension: 1700x805x1515

## GAS BAKERY OVEN

### RB-120G



- Voltage: 220V
- Power: 0.1KW
- Capacity: 1 Deck / 2 Tray
- Tray Suitable: 600x400mm
- Weight: 99.5KG
- Chamber Size: 860x670x220
- Dimension: 1330x840x615

### RB-130G

- Voltage: 220V
- Power: 0.1KW
- Capacity: 1 Deck / 3 Tray
- Tray Suitable: 600x400mm
- Weight: 105KG
- Chamber Size: 1300x670x220x3
- Dimension: 1770x840x615

### RB-240G



- Voltage: 220V
- Power: 0.2KW
- Capacity: 2 Deck / 4 Tray
- Tray Suitable: 600x400mm
- Weight: 185KG
- Chamber Size: 860x670x220x2
- Dimension: 1330x840x1190

### RB-260G

- Voltage: 220V
- Power: 0.2KW
- Capacity: 2 Deck / 6 Tray
- Tray Suitable: 600x400mm
- Weight: 256KG
- Chamber Size: 1300x670x220x6
- Dimension: 1770x840x1190





### RB-360G

- Voltage: 220V
- Power: 0.3KW
- Capacity: 3 Deck / 6 Tray
- Tray Suitable: 600x400mm
- Weight: 256KG
- Chamber Size: 860x670x220x3
- Dimension: 1330x840x1660

### RB-390G

- Voltage: 220V
- Power: 0.3KW
- Capacity: 3 Deck / 9 Tray
- Tray Suitable: 600x400mm
- Weight: 328KG
- Chamber Size: 1300x670x220x9
- Dimension: 1770x840x1660

### YXY-20A

- Voltage: 220V
- Power: 0.1KW
- Capacity: 1 Deck / 2 Tray
- Tray Suitable: 600x400mm
- Weight: 99.5KG
- Chamber Size: 860x670x220
- Dimension: 1330x840x615



### YXY-13A

- Voltage: 220V
- Power: 0.1KW
- Capacity: 1 Deck / 3 Tray
- Tray Suitable: 600x400mm
- Weight: 105KG
- Chamber Size: 1300x670x220x3
- Dimension: 1770x840x615

### YXY-40A

- Voltage: 220V
- Power: 0.2KW
- Capacity: 2 Deck / 4 Tray
- Tray Suitable: 600x400mm
- Weight: 185KG
- Chamber Size: 860x670x220x2
- Dimension: 1330x840x1190



### YXY-26A

- Voltage: 220V
- Power: 0.2KW
- Capacity: 2 Deck / 6 Tray
- Tray Suitable: 600x400mm
- Weight: 256KG
- Chamber Size: 1300x670x220x6
- Dimension: 1770x840x1190



### YXY-60A

- Voltage: 220V
- Power: 0.3KW
- Capacity: 3 Deck / 6 Tray
- Tray Suitable: 600x400mm
- Weight: 256KG
- Chamber Size: 860x670x220x3
- Dimension: 1330x840x1660

### YXY-90A

- Voltage: 220V
- Power: 0.3KW
- Capacity: 3 Deck / 9 Tray
- Tray Suitable: 600x400mm
- Weight: 328KG
- Chamber Size: 1300x670x220x9
- Dimension: 1770x840x1660

## NFD40FF



- Voltage: 380V
- Power: 1.2+3.5KW
- Capacity: O:4 Tray / P:8 Tray
- Tray Suitable: 600x400mm
- Weight: 538KG
- Dimension: 1460X1190X1980

### 2 DECK OVEN WITH BELOW PROOFER

## ELECTRIC DIGITAL OVEN

### YXD-1AE



- Voltage: 220V, Power: 2.67KW
- Tray Capacity: 4
- Tray Size: 438x315x10
- Interior Size: 460x375x360
- Temperature: 50-300°C
- Steam: No
- Dimension: 595X606X570mm

### CONVECTION OVEN

## PROOFER

### IP3TE8T

- Capacity: 8 Tray Proofer By Digital Panel
- Dimension: 1660X820X850

### IP3TG8T

- Capacity: 8 Tray Proofer By Digital Panel
- Dimension: 1770X890X850



- Volts: 220V/50Hz
- Power: 2.6KW
- Production: 20Kg/hour
- Capacity: 13 Pans
- Dimension: 490\*690\*1660mm

### FX-13



### IP2TE8T

- Capacity: 8 Tray Proofer By Digital Panel
- Dimension: 1220X820X850

### IP2TG8T

- Capacity: 8 Tray Proofer By Digital Panel
- Dimension: 1330X890X850



## EB-08A

- Voltage: 220V
- Power: 1300W
- Capacity: 8 Ounce
- Dimension: 520X380X670mm



**POP CORN MACHINE**

## EB-2488



**POP CORN MACHINE**

- Voltage: 220V
- Power: 1200W
- Capacity: 8 Ounce
- Dimension: 505X350X680mm

## HEC-02

- Voltage: 220V/50Hz
- Power: 0.9KW
- Dimensions: 710x710x510mm



**CANDY FLOSS MACHINE**

## YXD-266

- Voltage: 220V
- Power: 4.7KW
- Cooking Capacity: 8-12 Pcs
- Basket Qty: 4 Pcs
- Dimension: 810X600X640mm

## YXD-268

- Voltage: 220V
- Power: 6.21KW
- Cooking Capacity: 12-16 Pcs
- Basket Qty: 4 Pcs
- Dimension: 1030X670X800mm



**ELECTRIC ROTISSERIE**

# KIOSK ITEM

## SY-110



**ICE CRUSHER**

- Voltage: 220V/50HZ
- Electricity: 3.5A
- Circumgyrate : 1400rpm
- Power: 250W
- Production: 1.8Kg./m
- Devotion: About 1.8Kg.
- Weight: 20Kg
- Dimension: 350X290X430mm

## PE-2



- Voltage: 380V
- Power: 9.9KW
- Dimension: 534X607X950mm



**GAS SHAWARMA MACHINE**

**ELECTRIC SHAWARMA MACHINE**

## WYE-791

- Voltage: 220V/50Hz
- Power: 9KW
- Gas: LPG
- Weight: 27Kg
- Dimension: 480X630X790mm

## WYE-792

- Voltage: 220V/50Hz
- Power: 9.9KW
- Gas: LPG
- Weight: 31Kg
- Dimension: 530X630X920mm

## SY-300T



- Voltage: 220V/50Hz
- Power: 0.75KW
- Speed Of Pressing: 25 R/MIN
- Production Efficiency: 300Kg/Hr
- Weight: 54Kg
- Dimension: 440X370X540mm

**SUGAR CANE JUICER MACHINE**



# MARSSA ENTERPRISE

116D Rash Behari Avenue, 1st floor Kolkata: 700029

Email: [marssa.enterprise@gmail.com](mailto:marssa.enterprise@gmail.com)

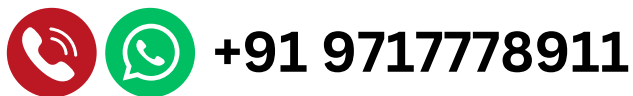

Scan This QR For Connect With Us