

PRODUCT CATALOGUE

MARSSA ENTERPRISE

A complete Commercial kitchen solution



Scan This QR For Connect With Us

  **+91 9717778911**

 **marssa.enterprise@gmail.com**

Company Profile

Marssa Enterprise is a Leading supplier of replacement parts, and servicing, of commercial equipment. Within 5 years of operation, we have built a solid reputation in the field. We work hard to stay ahead of the curve by staying up to date with the newest trends and technologies because the commercial kitchen business is always changing and evolving. Our industry-savvy team of professionals offers our clients the newest and most cutting-edge goods and services available.

Products:

To satisfy the needs of eateries, lodging facilities, coffee shops, air caterers, and other food service enterprises, we provide a large selection of commercial kitchen equipment and replacement components. We have a wide range of products, from tiny appliances to huge equipment like ice makers and oven dishwashers. All of our products are built to be dependable, long-lasting, and simple to use using premium materials.

Expert Advice

We understand that choosing the right equipment and services for your business can be a challenge, which is why we offer expert advice to help you make informed Decisions. Our knowledgeable staff is always available to answer your questions and provide you with the information you need to make the best decision for your business. Whether you are starting a new business or upgrading your existing equipment we can help you find the right products and services to meet your needs.

At Marssa Enterprise, we are dedicated to giving our clients the greatest experience possible. Our dedication to excellence, customer service, and professional guidance distinguishes us from other businesses in the sector. We can assist you with any needs you may have for servicing or replacement components for commercial kitchen equipment. To find out how we can support the success of your company, get in touch with us right now.

Brands



List of Clients



Cafeteria



Patisserie



Hotels

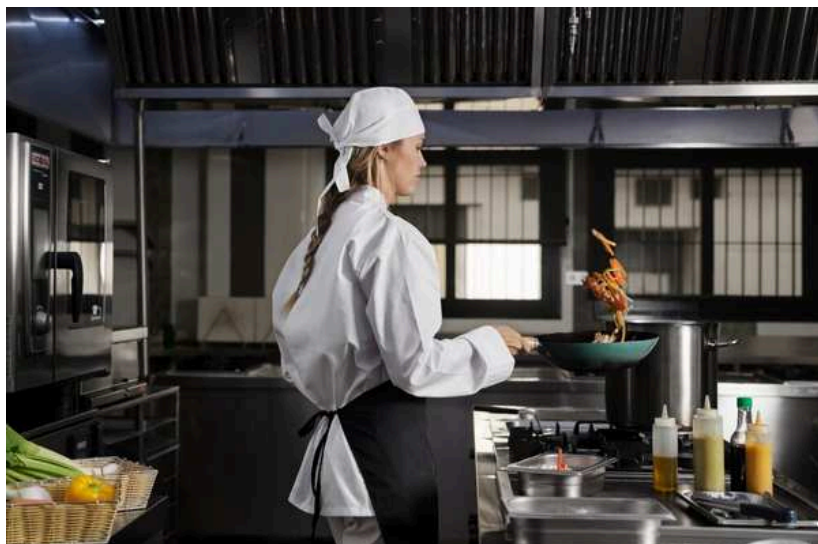

F & B



BAKERY



**EVERY SINGLE REQUEST IS DEALT PERSONALLY
BY OUR PEOPLE FOR YOUR BUSINESS**

We always prioritise your health. Every plastic part that comes into touch with food is BPA-free. This chemical's absence helps to make the product safe for your health.



TRINITYPRO COMBINED VEGETABLE SLICER/CUTTER MIXER 3,6 LT - SINGLE SPEED

SUPPLY VOLTAGE	
	: 602160 (COM36)
	: 200-240 V/1N ph/50/60 Hz
Electrical power max.	: 0.5 kW
Total Watts	: 0.5 kW
CAPACITY	
RPM	: 1500rpm
KEY INFORMATION	
External dimensions, Width	: 348 mm
External dimensions, Depth	: 334 mm
External dimensions, Height	: 527 mm
Shipping weight	: 23 kg

VEGETABLE SLICER TRS Vegetable Slicer - 1 Speed

SUPPLY VOLTAGE	
	: 600464 (TRS)
	: 200-240 V/1N ph/50/60 Hz
Electrical power max.	: 0.5 kW
Total Watts	: 0.5 kW
CAPACITY	
Performance (up to)	: 550 - kg/hour
KEY INFORMATION	
External dimensions, Width	: 252 mm
External dimensions, Depth	: 500 mm
External dimensions, Height	: 515 mm
Shipping weight	: 22 kg





Electrolux
PROFESSIONAL



With so many different extra accessories to choose from, vegetable peelers may be used for a variety of tasks, including washing, scouring, peeling, and even drying.



T10E / T15E



T25E

MODEL	601792 (T10E1)	601900 (T15E1)	602010 (T25EF150)
Supply Voltage	: 220-240 V/1N ph/50/60 Hz	220-240 V/1N ph/50/60 Hz	220-240 V/1N ph/50/60 Hz
Electrical power max.	: 0.37 kW	0.37 kW	1.1 kW
Total Watts	: 0.37 kW	0.37 kW	1.1 kW
CAPACITY			
Performance (up to):	: 160 - kg/hour	240 - kg/hour	400 - kg/hour
Capacity	: 10 kg	15 kg	25 kg
KEY INFORMATION			
External dimensions, Width	: 440mm	440 mm	585 mm
External dimensions, Depth	: 690mm	690 mm	785 mm
External dimensions, Height	: 680mm	750 mm	1215 mm
Shipping weight	: 48kg	50 kg	90 kg



Unloading hole



Abrasive plate and cylinder



Brushing plate



Drying basket (optional)

2 Door Refrigerator/ Freezer



2-DOOR REFRIGERATED COUNTER A304 R290 Product Code 790497

- Adjustable temperature range from -2 °C to +8 °C to suit meat, fish and dairy storage requirements.
- Performance guaranteed at ambient temperatures of +38°C.
- Built-in compressor
- Worktop in AISI 304 Stainless Steel.
- External doors, front, back and side panels in AISI 304 Stainless Steel.

2-DOOR FREEZER COUNTER A304 R290 Product Code 790513

- Performance guaranteed at ambient temperatures of +38°C.
- Adjustable temperature range from -18 °C to -22 °C to suit meat, fish, and dairy storage requirements.
- Worktop in AISI 304 Stainless Steel.
- Self-closing doors.
- External doors, front, back, and side panels in AISI 304 Stainless Steel.



Electrolux
PROFESSIONAL

3 Door Refrigerator/ Freezer



3-DOOR REFRIGERATED COUNTER A304 R290 Product Code 790500

- Adjustable temperature range from -2 °C to +8 °C to suit meat, fish, and dairy storage requirements.
- Performance guaranteed at ambient temperatures of +38°C.
- Internal panels and fittings in AISI 304 Stainless Steel.
- Built-in compressor
- Worktop in AISI 304 Stainless Steel.
- External doors, front, back, and side panels in AISI 304 Stainless Steel.

3-DOOR FREEZER COUNTER A304 R290 Product Code 790514

- Performance guaranteed at ambient temperatures of +38°C.
- Adjustable temperature range from -18 °C to -22 °C to suit meat, fish, and dairy storage requirements.
- Internal panels and fittings in AISI 304 Stainless Steel.
- Worktop in AISI 304 Stainless Steel.
- External doors, front, back and side panels in AISI 304 Stainless Steel.

2 X 1/2 Half Door Refrigerator/ Freezer



2x1/2-DOOR REFRIGERATED CABINET

A304 R600a Product Code 790478

- Adjustable temperature range from -2 °C to +8 °C to suit meat, fish, and dairy storage requirements.
- Performance guaranteed at ambient temperatures of +38°C.
- Internal panels and fittings in AISI 304 Stainless Steel.
- Built-in compressor.
- External doors, front, back, and side panels in AISI 304 Stainless Steel.

2x1/2-DOOR FREEZER CABINET

A304 R290 Product Code 790479

- Adjustable temperature range from -18 °C to -22 ° C to suit meat, fish, and dairy storage requirements.
- Performance guaranteed at ambient temperatures of +38°C.
- Internal panels and fittings in AISI 304 Stainless Steel.
- Built-in compressor.
- External doors, front, back, and side panels in AISI 304 Stainless Steel.

4 X 1/2 Half Door Refrigerator/ Freezer



4x1/2-DOOR REFRIGERATED CABINET **A304 R290 Product Code 790480**

- Adjustable temperature range from -2 °C to +8 °C to suit meat, fish and dairy storage requirements.
- Performance guaranteed at ambient temperatures of +38°C.
- Internal panels and fittings in AISI 304 Stainless Steel.
- Built-in compressor.
- External doors, front, back and side panels in AISI 304 Stainless Steel.

4x1/2-DOOR FREEZER CABINET **A304 R290 Product Code 790481**

- Performance guaranteed at ambient temperatures of +38°C.
- Adjustable temperature range from -18 °C to -22° C to suit meat, fish and dairy storage requirements.
- Internal panels and fittings in AISI 304 Stainless Steel.
- Built-in compressor.
- External doors, front, back and side panels in AISI 304 Stainless Steel.

6 X 1/2 Half Door Refrigerator



6x1/2-DRAWER REFRIGERATED COUNTER
A304 R290 Product Code 790502

- Adjustable temperature range from -2 °C to +8 °C to suit meat, fish and dairy storage requirements.
- Performance guaranteed at ambient temperatures of +38°C.
- Internal panels and fittings in AISI 304 Stainless Steel.
- Built-in compressor.
- Worktop in AISI 304 Stainless Steel.
- External doors, front, back and side panels in AISI 304 Stainless Steel.

1 Door Refrigerator/ Freezer



1-DOOR REFRIGERATED CABINET A304 R600a Product Code 790486

- Adjustable temperature range from -2 °C to +8 °C to suit meat, fish and dairy storage requirements.
- Performance guaranteed at ambient temperatures of +38°C.
- Developed and produced in ISO 9001 and ISO 14001 certified factory.
- Internal panels and fittings in AISI 304 Stainless Steel.
- Built-in compressor.
- External doors, front, back and side panels in AISI 304 Stainless Steel.

1-DOOR FREEZER CABINET A304 R290 Product Code 790487

- Performance guaranteed at ambient temperatures of +38°C.
- Adjustable temperature range from -18 °C to -22 °C to suit meat, fish and dairy storage requirements.
- Developed and produced in ISO 9001 and ISO 14001 certified factory.
- Internal panels and fittings in AISI 304 Stainless Steel.
- Built-in compressor.
- External doors, front, back and side panels in AISI 304 Stainless Steel.



Cold Beverage Dispensers

SIMPLICITY BUBBLERS

Your choice, limitless flavor, in one simple answer. Flexible choices, safe and easy to use, cold beverage dispensers are the answer to offering your customers innovative, delicious new drink options.

PNC	Description	Dimensions (w x d x h)
600925	2x9 ltrs. bowls, agitator	267x451x729 mm
600935	3x9 ltrs. bowls, agitator	518x451x818 mm
600931	4x9 ltrs. bowls, agitator	521x451x729 mm
600933	1x18 ltrs. bowl and 2x9 ltrs. bowls, agitator	521x451x729 mm
600927	1x18 ltrs. bowl, agitator	267x451x729 mm
600932	2x18 ltrs. bowls, agitator	521x451x729 mm

Temperature range from 1.7 - 5° C.

Refrigerant type: R290

Pre-mix dispenser with stainless steel base and clear plastic bowls.

User friendly design enables machine to dispense product till the very last drop



A chef wearing a white toque and a white chef's jacket with a dark blue collar is focused on cooking. He is using a metal pan on a stove, with a piece of meat being cooked. The kitchen background shows various cooking equipment and ingredients.

COOKING TECHNOLOGY



Electrolux
PROFESSIONAL



Gas Ranges on Convection/Static Oven (4 burners)

MODELS	391007	391008	391009	391010	391164
External dim. - mm					
width	800	800	800	800	800
depth	930	930	930	930	930
height	850	850	850	850	850
Gas power - kW	34,5	38,5	50,5	28	28
Electric power - kW	0,25	0,25	0,25	6	6
Burners - nr/kW	4x6	1x10+3x6	4x10	1x10+3x6	1x10+3x6
Gas convection oven	Yes	Yes	Yes	No	No
Electric Static oven	No	No	No	Yes	Yes
Electrical connection	230V 1N	230V 1N	230V 1N	400V 3N	230V 3N
	50Hz	50Hz	50Hz	50Hz	50Hz



Electrolux
PROFESSIONAL



**Power & efficiency all in one!
Boil, Braise, Grill, and fry with
the most efficient burners
available today**

Gas Ranges on Static Oven (6 or 8 Burners)

MODELS	391013	391014	391015	391016	391017
External dim. - mm					
width	1200	1200	1200	1200	1200
depth	930	930	930	930	930
height	850	850	850	850	850
Gas power - kW	52,5	68,5	56	72	73
Burners - nr/kW	2x10+4x6	6x10	2x10+4x6	6x10	2x10+6x6
Gas Static oven	Yes	Yes	No	No	No
Large oven	No	No	Yes	Yes	No
Open Cupboard	Yes	Yes	No	No	No



Electric Ranges with Square Plates on Oven

MODELS	391041	391167
External dim. - mm		
width	800	800
depth	930	930
height	850	850
Electric power - kW	22	22
Plates - nr	4x4	4x4
Electric Static oven	Yes	Yes
Electrical Connection	400V/3N	230V/3N
	50Hz	50Hz



Gas Tilting Braising Pans (80lt/100lt)

MODELS	391134	391135	391136	391138	391139
External dim. - mm					
width	800	800	800	1000	1000
depth	930	930	930	930	930
height	850	850	850	850	850
Gas power - kW	21	21	21	27	27
Electric power - kW	0,25	0,25	0,25	0,25	0,25
Nominal well capacity - lt	80	80	80	100	100
Duomat bottom	No	No	Yes	No	No
Mild steel bottom	Yes	Yes	No	Yes	Yes
Motorized lifting	No	Yes	No	No	Yes
Electrical connection	230V 1N	230V 1N	230V 1N	400V 3N	230V 3N
	50Hz	50Hz	50Hz	50Hz	50Hz

Electric Tilting Braising Pans (80lt/100lt)

MODELS	391143	391144	391145	391147	391148
External dim. - mm					
width	800	800	800	1000	1000
depth	930	930	930	930	930
height	850	850	850	850	850
Electric power - kW	13	13	13	17	17
Nominal well capacity - lt	80	80	80	100	100
Duomat bottom	No	No	Yes	No	No
Mild steel bottom	Yes	Yes	No	Yes	Yes
Motorized lifting	No	Yes	No	No	Yes
Electrical connection	400V 3N	400V 3N	400V 3N	400V 3N	400V 3N
	50Hz	50Hz	50Hz	50Hz	50Hz

SkyLine Pro Combi Boilerless Oven Digital 6GN1/1 electric 217920



	217920
Number of grids	6
Runner pitch - mm	67
External dimensions - mm	
width	867
depth	775
height	808
Electric power - kW	11
Electric amperage - A	16,3
Electrical connection	380-415V 3N 50/60 Hz
Bakery (400x600 mm)	

SkyLine Pro Combi Boilerless Oven Digital 10GN1/1 electric 217922



	217922
Number of grids	10
Runner pitch - mm	67
External dimensions - mm	
width	867
depth	775
height	1058
Electric power - kW	19
Electric amperage - A	28,3
Electrical connection	380-415V 3N 50/60 Hz
Bakery (400x600 mm)	

Model RCS511TS



‘-Microwave 1100W professional recommended for small volumes of use;-Ideal for fast food, can be used in snack bars, cafes, fast food, catering and small canteens; -The large room with a capacity of 34 liters allows to use large containers up to a size 2 / 3 GN containers or 2 1 / 3 GN; -Digital controls, 4 power levels, cycles of 3 kitchen timer, up to 60 minutes, 20 programs, magnetron 1.’

MICROWAVE OVEN,DIGITAL,34LT,1100W





Dishwashing

Sparkling Clean Dishes Every Time

WAREWASHING

Green & Clean Hood Type Dishwasher

COD 505073

Hood-type dishwasher, with single-skin manual hood, atmospheric boiler, 80r/h



HOOD TYPE DISHWASHER, WITH SINGLE SKIN MANUAL HOOD, ATMOSPHERIC BOILER, 80R/H

Main Features

- Requires only 2 liters of water per washing cycle thus ensuring low energy, water, detergent and rinse aid consumption.
- Built-in atmospheric boiler sized to raise incoming cold water to a minimum of 84 °C for sanitizing rinse. No external boiler is required. Constant temperature of 84 °C throughout the rinsing cycle regardless of the network's water pressure.
- Unique temperature interlock guarantees required temperatures in both the wash and final rinse.
- Incorporated Soft Start feature to offer additional protection to more delicate items.
- Slanted wash arms to avoid detergent-filled wash water dropping on clean dishes after the rinsing phase, thus guaranteeing ideal washing results.
- Cycle may be interrupted at any time by lifting the hood.
- Automatic self-cleaning cycle and selfdraining vertical wash pump and boiler to avoid bacteria proliferation.
- State-of-the-art electronic controls with builtin programming, self-diagnostics for serviceability and automatic interior self-cleaning cycle.
- IP25 protection against water jets, solid objects and small animals (larger than 6 mm).
- NSF/ANSI 3 and DIN 10512 compliant.
- Maximum capacity per hour of 80 racks or 1.440 dishes (High productivity mode) easy to switch to 63 racks or 1.134 dishes (NSF/ANSI 3 mode) by pressing a button.
- 45/84/150 seconds cycles (High productivity mode); 57/84/150 seconds cycles (NSF/ANSI 3 mode).
- The machine can be connected to cold water*.



CONSTRUCTION

- Heavy duty Stainless steel construction. Internal cavity as well as exterior panels are in 304 series Stainless steel.
- Pressed tank in front position to facilitate cleaning.
- Single skin hood supported by 3 springs to ensure smooth movement and guarantee operator safety.
- Specially designed Stainless steel wash/rinse arms and nozzles provide superior cleaning action.



ELECTRIC

Supply Voltage: 505073 (EHT8ROW) 400 V/3N ph/50Hz
 Convertible to 230V 1N~; 230V 3~
 Default Installed Power 9.9 kW

Boiler Heating Elements

Power *9 kW
 Tank heating elements 3 kW

Water:

Water supply temperature* 10-65° C
 Drain line size 20.5 mm
 Inlet water supply pressure 0.5-7 bar

Water consumption per

Cycle (lt)** 2
 Boiler Capacity (lt) 12
 Tank Capacity (lt) 24

Key Information

No. of cycles 3
 Duration cycle *45/84/150 sec.

Duration cycle- NSF/ANSI

3 compliant 57/84/150 sec.
 Racks per hour *80

Racks per hour – NSF/ANSI

3 compliant 1134
 Wash temperature 55-65° C

Wash temperature – NSF/

ANSI 3 compliant 75° C
 Rinse temperature 84° C

External dimensions, Width 746 mm

External dimension, Height 1549 mm

External dimension, Depth 755 mm

Net weight 106 kg

Shipping weight 117 kg

Shipping volume 1.23 m³

Packaging size

WxDxH 870 X 720 X 1630 mm

Noise level <68 dBA

** When connected to cold water, the cycle time will be prolonged accordingly. The machine will have productivity per hour of 48 racks at 10° C supply temperature or 55 racks at 20° C supply temperature.

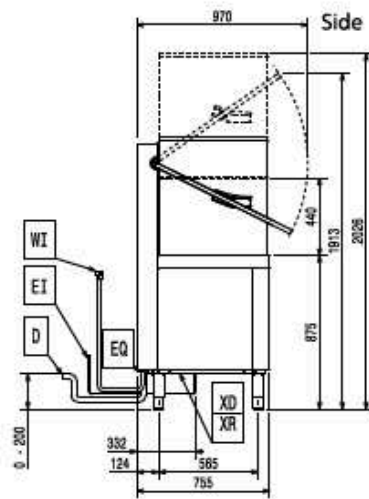
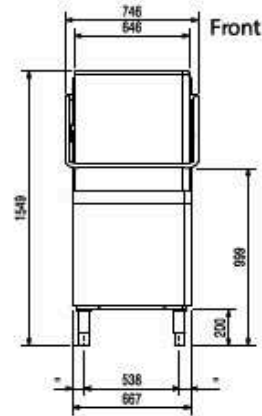

- CW1 = Cold Water inlet 1
- D = Drain
- EI = Electrical inlet (power)
- EO = Electrical Outlet
- HWI = Hot water inlet
- WI = Water inlet

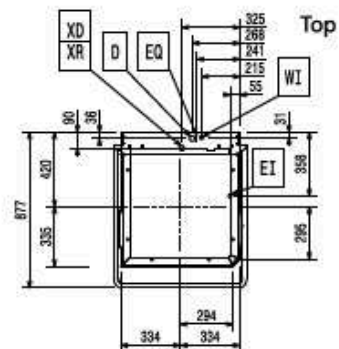

WAREWASHING

Undercounter WSC, Single skin, drain pump, detergent & rinse aid dispenser, 400220 (ELA3G)



Key Information

Baskets per hour*: **30**

Dishes per hour: **540**

Working cycles time (sec.): **120/180/240**

Wash temperature: **55-65°C**

Cell dimensions - width: **500 mm**

Cell dimensions - depth: **500 mm**

Cell dimensions - height: **330 mm**

Rinse temperature: **84 °C**

External dimensions, Width: **600 mm**

External dimensions, Depth: **648 mm**

External dimensions, Height: **820 mm**

Packaging size

(WxDxH): **740x640x1020 mm**

Sustainability

Water supply temperature*: **50 °C**

Water consumption per cycle (lt): **3**

Noise level: **<70 dBA**

Water

Pressure, bar min/max: **0.5-7 bar**

Drain line size: **20.5mm**

Inlet Water supply pressure: **7 - 102 psi (0.5 - 7 bar)**

Washing tank capacity (lt): **33**

Boiler Capacity (lt): **5,8**

Electric

Supply voltage: **400 V/3N ph/50 Hz**

Convertible to: **230V 3~; 230V 1N~**

Default Installed Power: **5.35 kW**

Boiler heating elements: **4,5 kW**

Tank heating elements: **2 kW**

Wash pump size: **0.736 kW**

Authorized, Electrolux Professional Spare Parts, Accessories, Consumables Stockists



MAIN BOARD HOOD
TYPE DISHWASHER



HEATING ELEMENT HOOD
TYPE DISHWASHER



RELAY HOOD
TYPE DISHWASHER



JUNCTION BOX HOOD
TYPE DISHWASHER



RFI FILTER HOOD
TYPE DISHWASHER



SPRING
CONVEYOR DISHWASHER



WASH PUMP
CONVEYOR DISHWASHER



SOLENOID VALVE
DISHWASHER



MAIN BOARD
COMBI OVEN



GAS VALVE
OVEN



GAS TAP
HOT PLATE



PILOT BURNER
HOT PLATE



RELIABILITY BUILT IN

Pre-Rinse Units / Faucets / Hose Reels



Model : EX-1DP00-H

Product Specifications:

Pre-Rinse Unit: Single Lever Deck Mount Faucet, 24" Riser, 2 Saddleback Cove / P.O. Box 1088
44" Flexible Stainless Steel Hose, 5SV-H High Flow Spray Valve, Travelers Rest, SC 29690
6" Wall Bracket 18" Flexible Steel Supply Hoses w/Check Valves



Model : EX-6WP00-H

Product Specifications:

Pre-Rinse Unit: Single lever Wall Mount Base Faucet, 18" Riser, 44" Flexible 2 Saddleback Cove/P.O. Box 1088 Stainless Steel Hose, High Flow Spray Valve, 6" Wall Bracket & G 1/2" Male Inlets



Model : EX-1DP12-H

Product Specifications:

Pre-Rinse Unit: Single Lever Deck Mount Faucet, Add-On Faucet, 12" Swing Nozzle, 18" Riser, 44" Flexible Stainless Steel Hose, 5SV-H High Flow Spray Valve, 6" Wall Bracket, 18" Flexible Supply Hoses w/ Check Valves



Model : EX-6WP12-H

Product Specifications:

Pre-Rinse Unit: Single Lever Wall Mount Base Faucet, Add-On 2 Saddleback Cove / P.O. Box 1088 Faucet, 12" Swing Nozzle w/ Full Flow Aerator, 18" Riser, 44" Flexible Stainless Steel Hose, High Flow Spray Valve & 6" Wall Bracket



Model : B-0113-B

Product Specifications:

Single hole deck mount mixing faucet with polished chrome plated brass body, 24" riser, 44" flexible stainless steel hose with heat resistant handle, 1.15 GPM spray valve, compression cartridges with spring checks, lever handles, 18" flexible stainless steel supply hoses with 1/2" NPSM / 5/8" compression connections, 6" adjustable wall bracket, spray valve holder and overhead spring.



Model : B-0133-B

Product Specifications:

Pre-Rinse Unit: EasyInstall 8" Wall Mount Mixing Faucet, Quarter-Turn Eterna Cartridges w/ Spring Checks, Lever Handles, 44" Flexible Stainless Steel Hose, 1.15 GPM Spray Valve, 6" Wall Bracket & 1/2" NPT Female Inlets

Model : 5HR-242-01

Hose Reel, Open, Powder Coated Steel, 50' x 3/8" ID Hose with Spray Valve

Features & Benefits :

Open coated hose reel
Black high flow spray valve
3/8" x 50' hose
Ratcheting system holds the length of hose until a slight tug to retract automatically 3/8" NPT female inlet
Adjustable hose bumper
Multi-fit bracket for wall, ceiling or under counter mounting

Details :

Box Dimensions: 23x21x9
Weight: 55.00 lbs (24.95 kg)
UPC: 671262581967, Harmonize: 8424.20.0000

Model : 5HR-232-01

Hose Reel, Open, Powder Coated Steel, 35' x 3/8" ID Hose with Spray Valve

Features & Benefits :

Open coated hose reel
Black high flow spray valve
3/8" x 35' hose
Ratcheting system holds the length of hose until a slight tug to retract automatically 3/8" NPT female inlet
Adjustable hose bumper
Multi-fit bracket for wall, ceiling or under counter mounting

Details :

Box Dimensions: 19x16x7.5
Weight: 34.05 lbs (15.44 kg)
UPC: 671262581912
Harmonize: 8424.20.0000



Chill Line





DIGITAL CONTROL *Touch a button to quickly change the defrost and temperature settings.*



Total control in only 4 buttons



Product code	790132	790133	790128	790129	790134	790135	790130	790131
External* / internal panels in AISI	304	304	304	304	304	304	304	304
Operating temperature at 43°C	-2/10	-22/-15	-2/10	-22/-15	-2/10	-22/-15	-2/10	-22/-15
Gross Capacity - lt	600	600	600	600	1300	1300	1300	1300
External dimensions - mm (wxdxh)	720x788x2000	720x788x2000	720x788x2000	720x788x2000	1440x788x2000	1440x788x2000	1440x788x2000	1440x788x2000
N° and type of grids (included)	3, GN 2/1	3, GN 2/1	4, GN 2/1	4, GN 2/1	6, GN 2/1	6, GN 2/1	8, GN 2/1	8, GN 2/1
Refrigeration type	R404a	R404a	R404a	R404a	R404a	R404a	R404a	R404a
Voltage/Phases/Frequency**	230/1/50	230/1/50	230/1/50	230/1/50	230/1/50	230/1/50	230/1/50	230/1/50



Product code	790096	790097	790098	790099	790100
With upstand	790108	790109	790110	790111	790112
Without worktop	790094	on request	on request	on request	on request
External* / internal panels in AISI	304	304	304	304	304
Operating temperature at 43°C	-2/10	-2/10	-2/10	-2/10	-2/10
Gross Capacity - lt	265	265	265	265	265
External dimensions - mm (wxdxh)	1238x710x850	1238x710x850	1238x710x850	1238x710x850	1238x710x850
N° and type of grids (included)	2, GN 1/1	1, GN 1/1	1, GN 1/1	-	-
Refrigeration type	R404a	R404a	R404a	R404a	R404a
Voltage/Phases/Frequency**	230/1/50	230/1/50	230/1/50	230/1/50	230/1/50



Product code	790101	790102	790103	790104	790105	790106	790107
With upstand	790113	790114	790115	790116	790117	790118	790119
Without worktop	790095	on request	on request	on request	on request	on request	on request
External* / internal panels in AISI	304	304	304	304	304	304	304
Operating temperature at 43°C	-2/10	-2/10	-2/10	-2/10	-2/10	-2/10	-2/10
Gross Capacity - lt	420	420	420	420	420	420	420
External dimensions - mm (wxdxh)	1721x710x850	1721x710x850	1721x710x850	1721x710x850	1721x710x850	1721x710x850	1721x710x850
N° and type of grids (included)	3, GN 1/1	2, GN 1/1	2, GN 1/1	1, GN 1/1	1, GN 1/1	-	-
Refrigeration type	R404a	R404a	R404a	R404a	R404a	R404a	R404a
Voltage/Phases/Frequency**	230/1/50	230/1/50	230/1/50	230/1/50	230/1/50	230/1/50	230/1/50

* Models with external panels in stainless steel and internal panels in AISI 304 available on request

** 60Hz models available on request



Main Features

- **Gross Volume: 550 Liters**
- **Product Dimension (WDXH)mm: 770X740X1970**
- **Temperature Range: 0°C to 10°C**
- **No of Glass Door: 2**
- **Light Inside (With Switch): LED**
- **Glow Sign (With Switch): Available/LED**



Voltas Hard Top Convertible Freezers Double Door 277 Liters, 3 Star

Main Features

- **Gross Volume: 277 L**
- **Energy Rating: 3 Star**
- **Product Dimension(WxDxH): 1180 x 665 x 830**
- **Temperature Range: <-18°C (Freezer), 0° to 7°C (Cooler)**



Voltas Hard Top Convertible Freezers - Double Door 177 Liters, 2 Star

Main Features

- **Gross Volume: 177 L**
- **Energy Rating: 2 Star**
- **Product Dimension(WxDxH): 834 x 665 x 830**
- **Temperature Range: <-18°C (Freezer), 0° to 7°C (Cooler)**



Voltas Hard Top Convertible Freezers - Double Door 421 Liters, 4 Star

Main Features

- **Gross Volume: 421 L**
- **Product Color: Grey**
- **Energy Rating: 4 Star**
- **Product Dimension(WxDxH): 1680 x 665 x 830**
- **Temperature Range: <-18°C (Freezer), 0° to 7°C (Cooler)**



Voltas Flat Glass Top Freezers - 275 Liters, 5 Star

Main Features:

- **Gross Volume: 275 L**
- **Energy Rating: 5 Star**
- **Product Dimension(WxDxH): 1180 x 620 x 855**
- **Temperature Range: <-18°C (Freezer)**



Voltas Water Dispenser Minimagic Spring F

Main Features

- **Product Dimension(WxDxH): 310 x 330 x 970**
- **Product Color: White**
- **Type: Floor Mounted**



Voltas Water Cooler 40/80 FSS - 80 Litres

Main Features:

- **Gross Volume: 80 L**
- **Product Dimension(WxDxH): 461 x 621 x 1311**
- **Food Grade Stainless Steel**



Voltas Water Cooler 60/120 FSS - 120 Litres

Main Features:

- **Gross Volume: 120 L**
- **Product Dimension(WxDxH): 566 x 746 x 1266**
- **Upto 40% Energy Efficient Compressor**

ICE Cube Machine





EASY TO CLEAN AND MAINTAIN

Time and money can be saved by arriving quickly for servicing and cleaning.

A M series ice maker's door is simple to remove off and just requires the removal of two screws to provide easy access.

The food zone of M Series ice makers is lined with white plastic, which makes it simple to see what has to be cleaned.

Parts that require cleaning can be taken out without the use of tools. It is possible to remove the trough, floats, pump, distribution tube, and water shield by hand. In the food zone, bacteria and fungi that produce slime and emit odours are inhibited by optional clean Air packs.

MODELS	POWER/VOLTAGE	DIMENSION	ICE PRODUCTION 24 HOURS (KG)	REFRIGERANT	BIN MODEL	BIN CAPACITY	MACHINE WEIGHT
MD0500A	0	30 x 24,5 x 21,5	214	R-410A	D-400C	165kg	100,5kg
MD0700A	0	30 x 24,5 x 21,5	290	R-410A	D-570C	241kg	122kg
MD1000A	0	30 x 24,5 x 29,5	237	R-410A	D-570C	241kg	153kg
MD1400A	0	48 x 24,5 x 29,5	649	R-410A	D-970C	400kg	210,5kg



ES60A



ES90A



ES0212A

Ice Production (kg)*	28	50	90
Bin Capacity	14	14	36
Width (cm)	50	50	66
Depth (cm)	57	57	67
Height (cm)	79	79	98
Power (Watts)	450	477	594
Refrigerant	R-134A	R-134A	R-404A
Weight	40 kg	41 kg	54 kg

Features & Benefit

- R-134 A or R-404 A, CFC-free refrigerant
- Easy access air filter designed for longer operation in greasy and dusty environments
- Storage bin liner is fabricated by rotational molding with polyethylene provides seamless and better insulation for longer ice storage
- CFC-free polyurethane foaming technology, better insulation for enhanced refrigeration efficiency while helping the environment
- Cleaning and sanitizing technology
- Apply the system of control board plus floor water & ice thickness probe, to improve the reliability and longevity of the ice machine.





Dynamic Preparation

Food Preparation & Processing Equipment





CL 50 TABLE-TOP

VEGETABLE PREPARATION MACHINES

Thanks to our range of Vegetable Preparation Machines, you can save hours of preparation in the kitchen: slicing, grating, chopping, shredding, julienne, brunoises, chip cutting, waffle cuts and even purees.

Induction motor	: ✓
Power	: 550 W
Voltage	: Single phase or Three phase
Speed	: 375 rpm
Feed hoppers	: Half moon hopper 2.2 L
	Cylindrical hopper Ø 58 mm and Ø 39 mm, Exactitube pusher - Included
Lid and bowl	: Metal
Motor base	: Composite material
Discs	: Not included

CHOOSE YOUR PACK OF DISCS

Pack of 8 discs for Restaurants						
Slicers 2 mm - 5 mm	Grater 2 mm	Julienne 3x3 mm	Dicing Equipement 10x10x10 mm	French Fries Equipment 10x10x10 mm	Wall disc holder	D-Clean kit
Pack of 12 discs for Institutions						
Slicers 2 mm - 5 mm	Grater 2 mm - 5 mm	Julienne 3x3 mm - 4x4 mm	Dicing Equipement 10x10x10 mm - 20x20x20 mm	French Fries Equipment 10x10x10 mm	Wall disc holder x2	
Asia Pack of 7 discs						
Slicers 2 mm - 5 mm	Grater 2 mm	Julienne 2x2 mm - 3x3 mm	Dicing Equipement 10x10x10 mm	Wall disc holder	D-Clean kit	
Eastern Europe Pack of 5 discs						
Slicers 2 mm	Grater 2 mm	Julienne 4x4 mm	Dicing Equipement 10x10x10 mm			

INNOVATION

EXACTITUBE PUSHER

The secret of exclusive cuts!
For slicing small and delicate ingredients such as chillis, gherkins, dry sausage, asparagus, spring onions, bananas, strawberries and grapes.



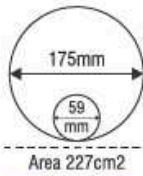

"Discover all the disk packs on page 49"



CL 55 PUSHER FEED-HEAD

VEGETABLE PREPARATION MACHINES

Especially designed for the preparation of large quantities of vegetables.

Induction motor	: ✓
Power	: 750 W / 1100W
Voltage	: Single phase or Three phase
Speed	: 375 rpm / 375rpm - 750rpm
Feed - heads	: Stainless steel automatic feed tube
	: Full moon pusher feed head 4,4 L
	: Cylindrical hoppers Ø 58 mm and Ø 39 mm,
	: Exactitube pusher - Included
Lid and bowl	: Metal
Motor base	: Stainless Steel
Mobile Stand	: Stainless Steel Equipped with 2 wheels and brake
Discs	: Not included



Pusher feed-head with built-in tube (surface area 227 sq.cm.)

CHOOSE YOUR PACK OF DISCS

Pack of 8 discs for Restaurants						
Slicers 2 mm - 5 mm	Grater 2 mm	Julienne 3x3 mm	Dicing Equipement 10x10x10 mm	French Fries Equipment 10x10x10 mm	Wall disc holder	D-Clean kit
Pack of 12 discs for Institutions						
Slicers 2 mm - 5 mm	Grater 2 mm - 5 mm	Julienne 3x3 mm - 4x4 mm	Dicing Equipement 10x10x10 mm - 20x20x20 mm	French Fries Equipment 10x10x10 mm	Wall disc holder x2	
Asia Pack of 7 discs						
Slicers 2 mm - 5 mm	Grater 2 mm	Julienne 2x2 mm - 3x3 mm	Dicing Equipement 10x10x10 mm	Wall disc holder	D-Clean kit	
Eastern Europe Pack of 5 discs						
Slicers 2 mm	Grater 2 mm	Julienne 4x4 mm	Dicing Equipement 10x10x10 mm			

CL 60 WORKSTATION

FLOOR STANDING VEGETABLE PREPARATION MACHINES

Especially designed for the preparation of large quantities of vegetables.



CL 60 WORKSTATION

CL 60 PUSHER FEED-HEAD CL 60 V.V. PUSHER FEED-HEAD

Induction motor	: ✓	✓
Power	: 1500 W	1500 W
Voltage	: Single phase or Three phase	Single phase or Three phase
Speed	: 375rpm - 750rpm / 100rpm - 1000rpm	375rpm - 750rpm / 100rpm - 1000rpm
Feed - heads	Stainless steel automatic feed head	Stainless steel automatic feed head
	Full moon pusher feed head 4,9 L	Full moon pusher feed head 4,9 L
	Cylindrical hoppers Ø 58 mm and Ø 39 mm,	Cylindrical hoppers Ø 58 mm and Ø 39 mm,
	Exactitube pusher - Included	Exactitube pusher - Included
	4 tubes: 2 Ø 50mm tubes and 2 Ø 70mm tubes	
Lid and bowl	: Metal	Stainless Steel
Motor base	: Stainless Steel	Stainless Steel
Equipped with	: 1 adjustable foot for all floor types	1 adjustable foot for all floor types
	2 wheels 1 stainless steel container for cutting attachments,	2 wheels 1 stainless steel container for cutting attachments
Accessories	: Ergo mobile trolley with 3 GN1x1 gastronorm pans - Included	
	Wall disc holder with 1 GN1x1 gastronorm pan - Included	
	3 mm Potato Ricer Equipment - Included	
Discs	: MultiCut Pack of 16 discs - Included	Not Included



2 MACHINES IN ONE!

Space saving and multifunctional, the Robot-Coupe Food Processor is one of the Chef's greatest allies even in a very small kitchen.

FOOD PROCESSORS CUTTERS & VEGETABLE SLICERS



MODELS	R 301 Ultra	R 402 V.V.	R 502 V.V.
Induction motor	: ✓	✓	✓
Power	: 650 W	1000 W	1500 W
Voltage	: Single phase	Single phase	Single phase
Speed	: 1500 rpm	300 to 3 500 rpm for cutter 300 to 1 000 rpm for vegetable slicer	
Pulse	: Yes	Yes	Yes
Cutter Bowl	: 3.7 L stainless steel	4.5 L stainless steel	5.9 L stainless steel
Blade	: Stainless steel smooth blade - Included		
Scraper arm	: No	Yes	Yes
Vegetable slicer	Half moon hopper 1,6 L		Half moon hopper 2,2 L
	Cylindrical hopper Ø 58 mm		Cylindrical hopper Ø 58 mm & Ø 39mm
			Exactitube pusher - Included
Discs	: Not Included		

CHOOSE YOUR PACK OF DISCS

Pack of 5 discs			
Slicers 2 mm - 4 mm	Grater 2 mm	Julienne 4x4 mm - 8x8 mm	
Asia Pack of 4 discs			
Slicers 2 mm - 4 mm	Grater 2 mm	Julienne 2x2 mm	
Asia Pack of 6 discs for R402 and R 402 V.V. only			
Slicers 2 mm - 4 mm	Grater 2 mm	Julienne 2x2 mm	Dicing Equipment 10x10x10 mm
Eastern Europe Pack of 3 discs			
Slicers 2 mm	Grater 2 mm	Julienne 4x4 mm	



Area 104 cm²

"Discover all the disk packs on page 47"



Area 139 cm²

"Discover all the disk packs on page 49"

THE MUST FOR PASTRY AND KITCHEN CHEFS!

With its bowl-base twin-blade assembly - a Robot-Coupe exclusivity - it is the Chef's ideal assistant. Whether you need small or large quantities, all your preparations can be made by just pressing a button: sauces, minced meat and fish, chopped onions, herbs and spices, ground nuts and chocolate, praline, kneading, etc.



TABLE TOP CUTTER MIXERS

MODELS	R-3-1500	R-3-3000	R-4-1500
Induction motor	: ✓	✓	✓
Power	: 650 W	650 W	700 W
Voltage	: Single phase	Single phase	Single phase
Speed	: 1500 rpm	3000 rpm	1500 rpm
Pulse	: Yes	Yes	
Bowl	: 3,7 L stainless steel	3,7 L stainless steel	4,5 L stainless steel
Blade	: Stainless steel smooth blade - Included		

THE SOLUTION FOR TEXTURE MODIFIED FOOD

The Blixer®, especially designed for the healthcare sector, turns raw products into texture modified foods. All foods, whether raw or cooked, sweet or savoury, whether entrees or mains, dessert or cheese, can be eaten by everyone at the table, even the most elderly.



BLIXER®

MODELS	BLIXER 2	BLIXER 3	BLIXER 4-1V
Induction motor	: ✓	✓	✓
Power	: 700 W	750 W	900 W
Voltage	: Single phase	Single phase	Single phase
Speed	: 3000 rpm	3000 rpm	3000 rpm
Pulse	: Yes	Yes	Yes
Motor base	: Composite Material	Composite Material	Metal
Bowl	: 2,9 L stainless steel	3,7 L stainless steel	4,5 L stainless steel
Watertight Lid	: Yes	Yes	Yes
Blixer arm	: Yes	Yes	Yes
Blade	: Stainless steel fine serrated blade with removable cap Included		
Number of 200g portions	: Single portion	2-10	2-15

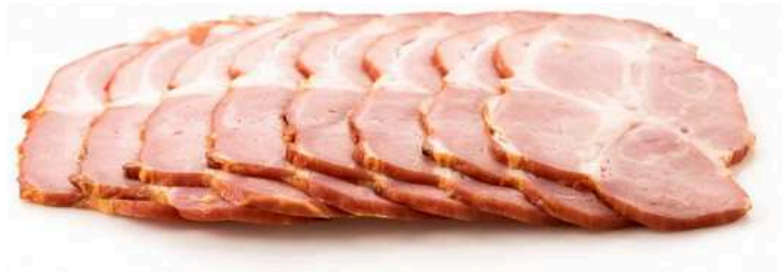

- Anodized cast aluminium alloy.
- Lat base for easy cleaning.
- Strong and silent-running asynchronous motor.
- Reliable poliV belt drive.
- Forged, hardened large thickness blades.
- Carriage running on self-lubricating bushes.
- Cast-in sharpener.
- Teflon coated or toothed blades available
- 25° blade inclination.

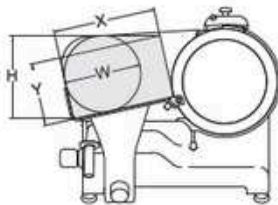
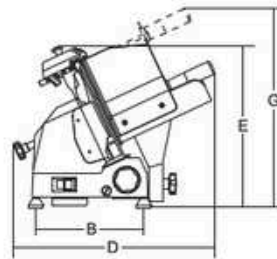
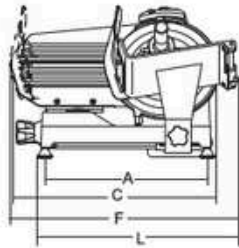

1. Hand guard
2. Underside motor protection plate
3. Without built-in sharpener 195-220

	Ø Blade	Motor	Cut thickness	Run of carriage	Hopper	A	B	C	D	E	F	G	L	X	Y	H	W	Net weight	Shipping	Gross weight
	mm/inch.	watt/HP	mm	mm	mm	mm	mm	mm	mm	mm	mm	mm	mm	mm	mm	mm	mm	kg	mm	kg
Topaz 195	195/8"	110/0,15	13	162	185x165	310	220	375	355	300	385	360	370	140	110	135	120	10,5	430x400 x370	12
Topaz 220	220/9"	145/0,20	13	245	200x220	380	250	440	410	330	550	400	450	200	130	145	140	13	600x500 x420	15
Topaz 250 C	250/10"	145/0,20	13	240	230x230	380	250	480	410	360	500	410	475	185	165	180	180	14	600x500 x420	16
Topaz 275	275/11"	145/0,20	13	235	220x225	412	255	520	410	370	525	455	505	200	190	205	205	16,5	600x500 x500	19
Mirra 300 Y09	300/12"	210/0,29	13	285	250x275													20,5	640x610 x510	23,5
Palladio 350	350/14"	370/0,50	23	310	305x270	465	340	680	575	455	710	530	580	270	225	275	250	37	760x640x700	46



TC 12E-22E

tritacarne meat grinders

- Costruzione in alluminio pressofuso lucidato
- Riduttore tritacarne a bagno d'olio
- Bocca ed elica tritacarne in ghisa trattata per uso alimentare, su richiesta anche in acciaio inox Aisi 304
- Piastra e coltello inox

Versione CE con:

- Comandi IP54 con NVR

Opzioni:

- Comandi con inversione
- TC 12: kit insacchitrice, imbuto \varnothing 14-19-23
- TC 22: kit insacchitrice, imbuto \varnothing 10-16-25

- Polished die-cast aluminum construction
- oil bath gearbox meat grinder
- Mouth and propeller mincer in untreated cast iron for food, on request in Aisi 304 stainless steel
- S7steel plate and knife

CE version with:

- IP54 protection rated controls and NVR device

Optionals:

- Reverse
- TC 12: stuffer kit, funnels \varnothing 14-19-23
- TC 22: stuffer kit, funnels \varnothing 10-16-25

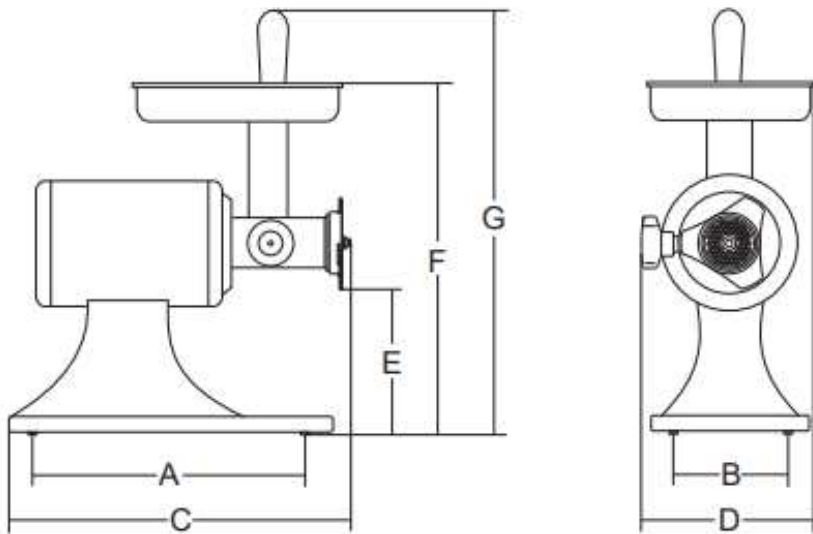

watt/HP

1ph/3ph

Kg/10 min.

\varnothing mm

mm

mm

mm

mm

mm

mm

mm

kg

mm

kg

TC 12 E

735/1

1ph/3ph

25

4.5

225

185

430

215

140

445

520

18

320x460x470

20

TC 22 E

800/1.2

1ph/3ph

33

4.5

225

185

440

215

135

445

520

21

320x460x470

23





TC 8 VEGAS

tritacarne
meat grinders



- Robusta struttura in alluminio anodizzato
- Corpo in alluminio anodizzato e fianchi in ABS antiurto o in acciaio inox
- Motore ventilato
- Riduttore tritacarne ermetico con ingranaggi a bagno d'olio
- Ingranaggi elicoidali temperati e rettificati
- Bocca ed elica tritacarne in lega di alluminio alimentare brillantata
- Piastra e coltello inox
- Pratico cassetto per piastra e coltello
- Inversione di marcia di serie
- Comandi IP54 con NVR.

- *Sturdy anodized aluminum frame*
- *Anodized aluminum body and ABS shockproof or s/steel sides*
- *Ventilated motor*
- *Hermetic meat grinder gearbox with oil bath gears*
- *hardened and ground helical gears*
- *Mouth and meat grinder alloy blade of alums*
- *S/steel plate and knife*
- *Compartment for knife and plate*
- *Reverse shuttle fitted as standard*
- *IP54 protection rated controls and NVR device*

					A	B	C	D	E	F	G			
	wait/tp		Kg/h.	ø mm	mm	mm	mm	mm	mm	mm	mm	kg	mm	kg
TC 8 Vegas	250/0.34	1ph	70	6	205	170	335	300	65	360	410	10	560x400x350	12
TC 8 Vegas FX	250/0.34	1ph	70	6	247	166	365	304	90	334	410	10	560x400x350	12

BONE SAWS



- ➔ Simple and sturdy machines that are safe and easy to use.
- ➔ Stand-alone structure made out of cast anodized aluminium, shiny, hygienic and rustproof.
- ➔ Features a counter, meat pusher and serving slicer in stainless steel A/SI 304
- ➔ 24V controls with safety micro-switch on door, redundant ECU and motor brake (EC).
- ➔ Utmost simplicity and accuracy when horizontally and vertically adjusting the upper pulley.
- ➔ Maximum blade adhesion to the pulley, thanks to the semi-curved shape of the pulleys and ideal adjustment.
- ➔ Airtight bearings on upper pulley.
- ➔ Powerful asynchronous and ventilated 4-pole motors protected by sealing oil sump
- ➔ Group washing cycle
- ➔ The machines use tempered 16 mm blades to shred bone, frozen or fresh.

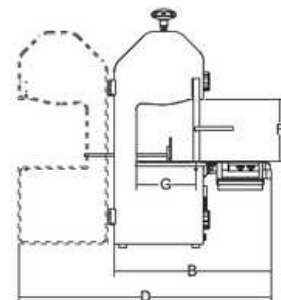
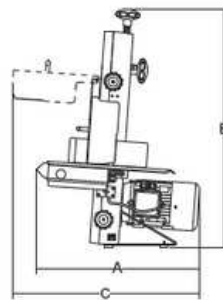

	Blade length	Motor	Pulley	Working surface	A	B	C	D	E	F	G	Net weight	Shipping	Gross weight
	mm	Hp/lr.p.m.	mm	mm	mm	mm	mm	mm	mm	mm	mm	Kg	mm	kg
SO 1550 F3	1550	1ph 1/1400 - 3ph 1,5/1400	210	400x420	530	510	606	822	778	215	195	32	720x570x1200	44
SO 1650 F3	1650	1ph 1/1400 - 3ph 1,5/1400	210	430x475	530	600	640	950	915	250	200	39	720x570x1200	51
SO 1840 F3	1840	1ph 1/1400 - 3ph 1,5/1400	250	430x475	530	600	640	950	915	250	240	40	720x570x1200	52
SO 2020 Inox	2020	900	250	480x600								61	760x640x1430	73



Slices discs DF

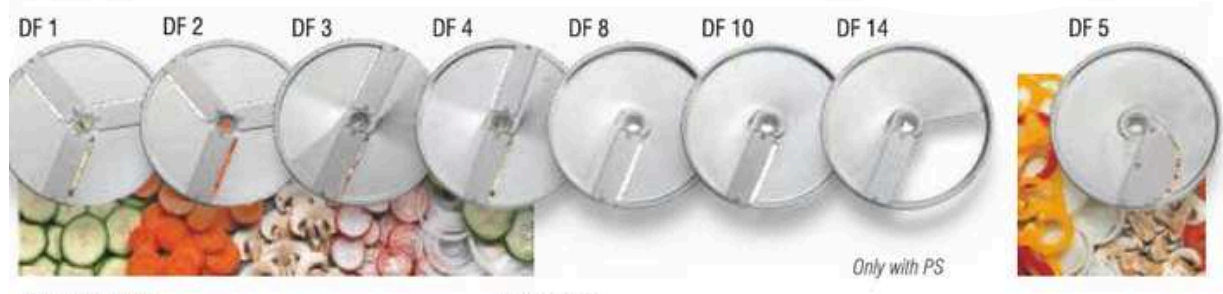

Only with PS

Discs DQ sticks



Dicing discs



Discs for shredding DT



PS discs only use with DF

Grating discs



Aluminium feed hopper lid with side opening



Chute for continuous product ejection, with safety microswitch.



PS dicing disc cleaner



Discs holder

TS-678



- Power: 2.2KW
- Voltage: 200-230V 50HZ
- Size: 316X316 mm
- Size Of Control Box: 128x42 mm

- Power: 3.4KW
- Voltage: 200-230V 50HZ
- Size: 735x435x65 mm
- Cutout Size: 680x400 mm

TS34C01



TM-767



- Capacity: 2 Ltrs
- Voltage: 220-240V~ / 50-60Hz
- Power (W): 2238
- 3HP High Efficient Motor
- Function: Variable Speed Control
- Dimensions: 20x24x51cm



TM-800A



- Capacity (l): 1.5
- Voltage: 220V
- Power (W): 2238
- 3HP Motor
- Function: Variable Speed
- Controls Type: Touchpad
- Dimensions: (L)20x(W)24x(H)42cm

TM-800AQ OMNI-Q



- Capacity (l): 1.5
- Voltage: 220V
- Power (W): 2238
- 3HP Motor
- Function: Variable Speed
- Controls Type: Touchpad
- Dimensions: (L)30x(W)27x(H)46cm



GES 10



Waffle Maker

- Voltage: 230V
- Power: 1.6KW
- Capacity: 40 Waffles/Hr
- Squares : 20 x 25 mm,
- Waffle Size: 100x170x22 mm
- Dimensions: 305x510x310 mm



- Voltage: 230V
- Power: 3KW
- Capacity: 48 Panini/Hr
- Cooking Surface: 360X240
- Dimensions: 380X460x280



PANINI



SEM 600 PDS



SALAMANDER

- Voltage: 230V, Power: 3KW
- 3 Sides Open
- Working Height: Min 90/Max 245mm.
- Cooking Surface: 495x375 mm
- Dimensions: 600x640x590 mm

GR 40 E



SHAWARMA MACHINE

- Voltage: 230V, Power: 3.6KW
- 3 Incoloy Heating Elements
- Capacity Meat: 15KG
- Spit Height: 400mm
- Dimensions: 580x660x690 mm

FD 50



FRYER

- Voltage: 230V, Power: 3.2KW
- Volume: 5 Ltrs
- Capacity (French Fries): 1.5KG
- Output (French Fries): 8KG/Hr
- Basket Size: 140x260x100mm
- Dimensions: 215x425x320mm

- Voltage: 230V
- Power: 2KW
- Capacity: 96 Hamburgers Or Steaks/Hr
- Cooking Surface: 260X240
- Dimensions: 280X460x280



SAVOYE





TECHNICAL DATA

MODEL	Pratica E1	Pratica E2
Dimensions(WxHxD)	339x500x475 mm	585x500x475 mm
Weight	34 kg	47 kg
Display	No	No
Number of buttons	5	5
Steam boiler capacity	4 L	11 L
Voltage	220 - 240 V 50/60 Hz	220 - 240 V 50/60 Hz
Watts 1	850 W	3150 W



TECHNICAL DATA MANUAL / AUTOMATIC GRINDER

MODEL	X010
Assembled (HxWxL) mm	650 x 280 x 390
Weight	14Kg
Grinding stones diameter	64mm
Bean Hopper capacity	1.2Kg.
Grinding capacity	6-8Kg/hour
Dispenser capacity	240gr. (powder coffee)
Dispensing capacity	5-9gr/dose
Electric Power	370watt

MAIN FEATURES

- Durable and unbreakable hopper .
- Food grade hardened tooling steel grindstones
- Stepless adjustment for accurate grinding
- 4 optional colors: Black Red Silver and white
- Manual or Automatic control.



TECHNICAL DATA

MODEL	Mya Ultra
Average Daily Production	400 cups
Dimensions(WxHxD)	290x814x592 mm
Weight	42 kg
User interface	10" touch screen
Spout clearance	90 - 195 mm
Bean hopper capacity	1,3 kg
Instant canisters	-
Coffee boiler capacity	Heat exchanger
Steam boiler capacity	4 l
Group capacity	10 - 20 g (M - Brew XL)
Communication protocol	MDB, Executive
Voltage	220 - 240 V 50/60 Hz



White



Black



Dimensions
W368 X D550 XH 585 mm

MAIN FEATURES

Coffee boiler capacity	0.6 l
Coffee hopper capacity	0.6 Kg
Instant container capacity	0.8 l
Internal tank capacity	4.0 l
N° of grinders	1-2
N° of mixer	0-2
N° of cups per minute	2 Espresso 1 Cappuccino
Weights	Net 25 Kg Gross 30 Kg

ELECTRICITY SUPPLY

100-120 V 1+N 50/60 Hz 1.400 W
220-240 V 1+N 50/60 Hz 1.700 W

WATER SUPPLY

Internal water tank
Water mains connection
Jolly: water tank + mains connection

Black



ADD-ON UNITS

Fridge with digital temperature

Capacity	7.5 l
Electricity supply	220/230V 50/60Hz
Net weight	14 Kg
Cup warmer	Optional

Dimensions
W 225 X D 462 X H 392 mm





FA-520B
Power : ½HP
Size : 2100x850x1100mm
Conveyor Size : 515x2000mm



FA-450A
Power : ½HP
Size : 1800x760x600mm
Conveyor Size : 430x1700mm



FA-520A
Power : ½HP
Size : 1800x850x600mm
Conveyor Size : 515x1700mm



HAseries / SP-502A

Model

Motor

750W, grease packed ball bearing, air-cooled, 110V/60Hz, 220V/50Hz, Single phase

Controls

Spar Mixer controls are side-mounted to give easy access in cramped kitchen environments.

Attachment Hub

#10 Attachment Hub can use Pasta Kit, Meat Mincer and Vegetable Prep Attachment.

Transmission

The unique design yields high-torque mixing power while avoiding the high cost encountered repairing direct-drive transmission components.

Speeds(Agitator rpm)

1st gear 71 rpm 6rd gear 306rpm
2nd gear 120rpm 7rd gear 355 rpm
3rd gear 169rpm 8rd gear 401 rpm
4rd gear 210rpm 9rd gear 443 rpm
5rd gear 253rpm 10rd gear 490 rpm

Bowls and Agitators

Standard equipment includes a 5Litres high quality stainless steel bowl, dough hook, flat beater, and whip. A sturdy hand lever on the body column raises and lowers the bowl as well as locking in place at the top and bottom positions.

Finish

Powder Coating

Shipping Information

N.W. 15.25 kgs
G.W. 17.45 kgs

Size (L x W x H)

345mm x 389mm x 434mm



MAseries / SP-502

Motor

750W, grease packed ball bearing, air-cooled, 110V/60Hz, 220V/50Hz, Single phase

Controls

Spar Mixer controls are side-mounted to give easy access in cramped kitchen environments

Attachment Hub

#10 Attachment Hub can use Pasta Kit, Meat Mincer and Vegetable Prep Attachment.

Transmission

The unique design yields high-torque mixing power while avoiding the high cost encountered repairing direct-drive transmission components.

Speeds(Agitator rpm)

1st gear 71 rpm 6rd gear 306rpm
2nd gear 120rpm 7rd gear 355 rpm
3rd gear 169rpm 8rd gear 401 rpm
4rd gear 210rpm 9rd gear 443 rpm
5rd gear 253rpm 10rd gear 490 rpm

Bowls and Agitators

Standard equipment includes a 5Litres high quality stainless steel bowl, dough hook, flat beater, and whip. A sturdy hand lever on the body column raises and lowers the bowl as well as locking in place at the top and bottom positions.

Finish

Powder Coating

Shipping Information

N.W. 15.07 kgs
G.W. 17.27 kgs

Size (L x W x H)

345mm x 389mm x 434mm

Juicer

SANTOS



SANTOS CITRUS JUICER NO. 11

- Single Phase: 220-240V-50/60Hz
- Power: 130W - CE
- Speed: 1500 rpm (50 Hz)
- Output: 30 Liters Of Juice
- Per Hour (8 Gallons)
- Dimensions: 230X300X350



SANTOS CITRUS JUICER NO. 10

- Single Phase: 220-240V-50/60Hz
- Power: 230W - CE
- Speed: 1500 rpm (50 Hz)
- Output: 30 Liters Of Juice
- Dimensions: 200X300X380



- Single Phase: 220-240V-50/60Hz
- Power: 650 W
- Speed: 5 to 80 rpm
- Pulp Container: 4 Litres
- Output: 60 l/h
- Dimensions: 412X236X642mm



SANTOS COLD PRESS JUICER NO. 65

Value Line

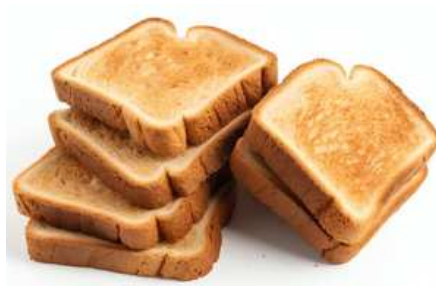

RB-110ES

- Voltage: 220V
- Power: 3.2KW
- Capacity: 1 Deck / 1 Tray
- Weight: 55Kg
- Chamber Size: 640x455x180
- Dimension: 925X570X430mm



RB-110GS

- Voltage: 220 V
- Power: 100 W
- Capacity: 1 DACK /1 TRAY
- Chamber Size: 670X530X180 mm
- Dimension: 1050X660X490 mm

EP-1P



- Voltage: 220V
- Power: 2KW
- Capacity: 1 Deck
- Weight: 24Kg
- Chamber Size: 400x400x1
- Dimension: 560X570X280mm

EP-2P



- Voltage: 220V
- Power: 3KW
- Capacity: 2 Deck
- Weight: 33Kg
- Chamber Size: 400x400x2
- Dimension: 560X570X440mm



HX-1



- Voltage: 220V
- Power: 6.3KW
- Working Area: 560x385
- Weight: 47Kg
- Dimension: 1080/1380X555X420



CONVEYOR PIZZA OVEN

EF-4SC

- Voltage: 220V/50Hz/1Ph
- Power: 2000W
- Capacity: 4 Ltr
- Weight: 5Kg
- Dimension: 265X385X320mm

EF-8SC

- Voltage: 220V/50Hz/1Ph
- Power: 2800W
- Capacity: 8 Ltr
- Weight: 6.2Kg
- Dimension: 310X410X340mm



SINGLE TANK ELECTRIC FRYER

EF-6SC

- Voltage: 220V/50Hz/1Ph
- Power: 2500W
- Capacity: 6 Ltr
- Weight: 5.6Kg
- Dimension: 310X410X290mm

EF-11SC

- Voltage: 220V/50Hz/1Ph
- Power: 3200W
- Capacity: 11 Ltr
- Weight: 11.4Kg
- Dimension: 370X440X340mm

EF-4TC

- Voltage: 220V/50Hz/1Ph
- Power: 2x2000W
- Capacity: 4x2 Ltr
- Weight: 9.2Kg
- Dimension: 490X385X320mm



DOUBLE TANK ELECTRIC FRYER

EF-6TC

- Voltage: 220V/50Hz/1Ph
- Power: 2x2500W
- Capacity: 6x2 Ltr
- Weight: 10.2Kg
- Dimension: 590X385X220mm

EF-8TC

- Voltage: 220V/50Hz/1Ph
- Power: 2x2800W
- Capacity: 8x2 Ltr
- Weight: 11Kg
- Dimension: 592X410X340mm

EF-11TC

- Voltage: 220V/50Hz/1Ph
- Power: 2x3200W
- Capacity: 11x2 Ltr
- Weight: 15Kg
- Dimension: 725X440X345mm



ELECTRIC FRYER

- Voltage: 220V/50Hz/1Ph
- Power: 2500W
- Capacity: 6 Ltr
- Weight: 4.5Kg
- Dimension: 275X430X290mm

EF-6L



HOT LINE

EF-6LX2



- Voltage: 220V/50Hz/1Ph
- Power: 2x2500W
- Capacity: 6x2 Ltr
- Weight: 9Kg
- Dimension: 550X430X290mm



- LPG Gas Operated
- Capacity: 8 Ltrs
- Weight: 22Kg
- Dimension: 300X600X550mm

GF-971



ELECTRIC TOASTER

4-ATS



4 SLICE SLOT TOASTER

- Voltage: 220V/50Hz/1Ph
- Power: 2240W
- Capacity: 4 Slice
- Weight: 6Kg
- Dimension: 370X210X225mm



- Voltage: 220V/50Hz/1Ph
- Power: 3240W
- Capacity: 6 Slice
- Weight: 8Kg
- Dimension: 460X210X225mm

6-ATS



6 SLICE SLOT TOASTER

CONVEYOR TOASTER

HOT LINE



TT-300

- Voltage: 220V/50Hz/1Ph
- Power: 2200W
- Capacity: 300-350 Slice/Hr
- Weight: 16Kg
- Dimension: 560X385X380mm

TT-150

- Voltage: 220V/50Hz/1Ph
- Power: 1300W
- Capacity: 150-180 Slice/Hr
- Weight: 14Kg
- Dimension: 510X360X380mm

TT-400

- Voltage: 220V/50Hz/1Ph
- Power: 2600W
- Capacity: 450-500 Slice/Hr
- Weight: 30.5Kg
- Dimension: 510X540X380mm

SANDWICH GRILLER

GH-811A

- Voltage: 220V
- Power: 1.8KW
- Upper Grill: 216x215
- Lower Grill: 240X280
- Temperature: 300°C
- Head: 1
- Dimension: 350X400X210mm

GH-811E

- Voltage: 220V
- Power: 2.2KW
- Upper Grill: 335x218
- Lower Grill: 365X277
- Temperature: 300°C
- Head: 1 Jumbo
- Dimension: 425X400X210mm



SINGLE HEAD SANDWICH GRILLER

GH-813A

- Voltage: 220V
- Power: 1.8+1.8KW
- Upper Grill: 216x215
- Lower Grill: 500X280
- Temperature: 300°C
- Head: 2
- Dimension: 580X400X210mm



DOUBLE HEAD SANDWICH GRILLER



TABLE TOP GRIDDLE PLATE



GH-818



- Full Smooth
- Voltage: 220V
- Power: 3KW
- Dimension: 550X430X240mm

GH-820



- Full Smooth
- Voltage: 220V
- Power: 4.4KW
- Dimension: 730X470X240mm

GH-822



- 2/3 Smooth And 1/3 Ribbed
- Voltage: 220V
- Power: 4.4KW
- Dimension: 730X470X240mm

WAFFLE MACHINE

RW-1



- VOLTS: 220V/50HZ
- POWER: 1.2 KW
- SIZE: 250*380*300mm



UWB-1



ROTATING WAFFLE MACHINE

- Voltage: 220V
- Power: 1KW
- Temperature: 0-300°C
- Waffle Plate: Dia 20cm
- Dimension: 250X360X270mm

TABLE TOP WAFFLE MACHINE

WAFFLE MACHINE

- Voltage: 220V
- Power: 1.6KW
- Temperature: 0-300°C
- Dimension: 282X380X230mm



SQUARE WAFFLE MACHINE

UWB-2



- Voltage: 220V
- Power: 1.2KW
- Temperature: 0-300°C
- Waffle Plate: Dia 20cm
- Dimension: 500X360X360mm

TABLE TOP WAFFLE MACHINE



ZU-1

- Voltage: 220V
- Power: 1KW
- Temperature: 0-300°C
- Dia: 22cm
- Dimension: 282X380X236mm



TABLE TOP CONE BAKER

FWH-2P



DISPLAY WARMER

- Voltage: 220V/50Hz/1Ph
- Power: 1200W
- Weight: 28Kg
- Dimension: 660X500X620mm

FWH-60



DISPLAY WARMER

- Voltage: 220V/50Hz/1Ph
- Power: 1840W
- Weight: 33Kg
- Dimension: 660X480X610mm

PW-14



FOOD DISPLAY STEAMER

- Voltage: 220-240V
- Power: 0.85KW
- Weight: 38Kg
- Dimension: 550X450X777mm

DS-500H



FOOD DISPLAY STEAMER

- Voltage: 220-240V
- Power: 0.9KW
- Weight: 24Kg
- Dimension: 380X400X745mm

ELECTRIC SALAMANDER



EB-450

- Voltage: 220V
- Power: 2800W
- Tray/Grid: 440x320
- Temperature: 300°C
- Weight: 39Kg
- Dimension: 450X450X500mm

EB-600

- Voltage: 220V
- Power: 4000W
- Tray/Grid: 585x320
- Temperature: 300°C
- Weight: 49Kg
- Dimension: 600X450X500mm

AT-936

- Voltage: 220V
- Power: 2000W
- Weight: 11Kg
- Dimension: 610X310X280mm



AT-937

- Voltage: 220V
- Power: 4000W
- Weight: 24Kg
- Dimension: 790X450X490mm



AT-938

- Voltage: 220V
- Power: 2200W
- Weight: 16Kg
- Dimension: 580X390X380mm

DE-01

- Voltage: 220V/50Hz/1Ph
- Power: 3000W
- Weight: 23Kg
- Dimension: 450X470X230mm



CREPE MACHINE

VS-550

- Voltage: 230V/50Hz/1Ph
- Power: 550W
- Weight: 22Kg
- Dimension: 560X290X560



VEGETABLE SLICER



EPC-4A



ELECTRIC PASTA COOKER

- Voltage: 220-240V/50-60Hz
- Power: 4KW
- Temperature: 50-110°C
- Weight: 12.8Kg
- Dimension: 450X530X450mm

HOT LINE



ERC-23L



- Voltage: 220V/50Hz
- Power: 3KW
- Capacity: 23L



ELECTRIC RICE COOKER

TS-6000B



SOUP KETTLE

- Voltage: 220V/50Hz/1Ph
- Power: 600W
- Weight: 4.5Kg
- Dimension: 345X360mm



PO-1120

- Voltage: 220V
- Power: 6.3Kw
- Weight: 47Kg
- Working Area: 560x385
- Dimension: 1080/1380x555X420mm



PIZZA CONVEYOR OVEN





SXC-12E

- Voltage: 220V
- Power: 0.55KW
- Capacity: 120Kg/Hr
- Weight: 27Kg
- Dimension: 400X190X410mm

MEAT GRINDER



- Voltage: 110/220V/50-60Hz
- Power: 1.1KW
- Wheel Diameter: 210mm
- Band Saw's Speed (M/S): 15
- Table Size (CM): 61x53
- Gross Weight: 65Kg
- Package Size (CM): 63X51X96.5

SXC-22E

- Voltage: 220V
- Power: 0.75KW
- Capacity: 220Kg/Hr
- Weight: 35Kg
- Dimension: 410X240X450mm

J-210



BONE SAW MACHINE

MSSL220



- Speed Blade: 300 RPM
- Diameter Blade: Ø 220 mm
- Net weight: 14 kg
- Dimensions: 450x280x320 mm
- 220-230V/50Hz/1Phase

MEAT SLICER



PLATE WARMER

HOT LINE

DR-1



- Voltage: 220-240V/50-60Hz
- Power: 0.4KW
- Tube: 1
- Weight: 31Kg
- Dimensions: 455X555X925mm

PLATE WARMER

DR-2



- Voltage: 220-240V/50-60Hz
- Power: 0.8KW
- Tube: 2
- Weight: 48Kg
- Dimensions: 455X950X925mm

PLATE WARMER

DR-3



- Voltage: 220V
- Power: 400W
- Tube: 1
- Weight: 19Kg
- DIA: 405X725mm

PLATE WARMER



SY-8



POTATO PEELER

- Voltage: 220V/50Hz
- Power: 0.37KW
- Capacity: 8Kg
- Dimension: 430X430X725mm



HD-05



HOT DOG ROLLER

- Voltage: 220V/50-60Hz
- Power: 1000W
- Weight: 8Kg
- Dimension: 560X255X190



HDS-03



HOT DOG STEAMER

- Voltage: 220V/50Hz
- Power: 0.8KW
- Dimension: 467x300x385 mm
- Net Weight: 9Kg

A031



HEATING / DECORATIVE LAMP

- Voltage: 220V
- Power: 250W
- Diameter: 175mm
- Adjustable Height: 0.6~1.8mm

BC110-100



DIGITAL WATER BOILER

- VOLTS: 220~240V/50Hz
- POWER: 2500W
- TIMING CLOCK: V
- MATERIAL: S/S
- CAPACITY: 6 LTR.
- HOUR WATER TAKEOUT: 22 LTR.
- DIMENSIONS: 190X240X520 MM



HW-TP3.5A-02

- Dimension(mm): 350*450*150
- Fire Adjustment: 9 power levels
- Watt: 3,500W
- Voltage: AC 220V, 50Hz
- Display mode: LED
- Half-bridge technology when the cooker is in low -power, will continue to be heated.
- HW-3.5KW-F main board

HW-TP5A-02

- Dimension(mm): 380*500*200
- Fire Adjustment: 9 power levels
- Watt: 5000W
- Voltage: AC 220V, 50Hz
- Display Mode: LED
- Half-bridge technology when the cooker is in low -power, Will continue to be heated Continuous working 12 hours.

TABLE TOP INDUCTION PLATE

- Dimension(mm): 340*340*100
- Fire adjustment: 9 power levels
- Watt: 3500W
- Voltage: AC 220V, 50Hz
- Display mode: LED

HW-QP3.5-04D



TABLE TOP INDUCTION PLATE



HK-BS-31



- Voltage: 220V
- Power: 0.25KW
- Blade Qty: 31Pcs
- Bread Thick: 12mm
- Weight: 71KG
- Dimension: 650x740x780

BREAD SLICER

JDR520B

- Voltage: 220/1Ph
- Power: 0.55KW
- Roller Range: 1~35 mm
- Roller Diameter (mm): 89
- Conveyor Belt Size: 500*1980 mm
- Maximum Roll Weight: 5Kg
- Weight: 150KG
- Dimension: 2400*920*650 mm



TABLE TOP DOUGH SHEETER

JDR520



- Voltage: 220/1Ph
- Power: 0.55KW
- Roller Range: 1~35 mm
- Roller Diameter (mm): 89
- Maximum Roll Weight: 5KG,
- Weight: 190KG
- Dimension: 2350*870*1230
- Conveyor Belt Size(mm): 500*1980

FLOOR TYPE DOUGH SHEETER

JDR630

- Voltage: 220/1Ph
- Power: 0.75Kw
- Roller Range: 1~35 mm
- Roller Diameter (mm): 73
- Maximum Roll Weight: 6.5Kg
- Net Weight: 260Kg
- Dimension: 3480*1110*1280
- Conveyor Belt Size(mm): 610*2800



FLOOR TYPE DOUGH SHEETER

NFQ-380

- Voltage: 220-380V
- Power: 0.8KW/1.13KW
- Plate Size: 380mm
- Weight: 237KG
- Yield: 10-1000g
- Dimension: 1450x670x1100



BREAD MOULDER

SPIRAL MIXER



HS30S

- Voltage: 380V
- Power: 1.3KW/1.7KW
- Speed (R/Min): 15/23/150/230
- Volume: 28L
- Capacity: 12.5KG
- Weight: 167KG
- Dimension: 850x430x940

HS40S

- Voltage: 380V
- Power: 1.2KW/1.8KW
- Speed (R/Min): 12/24/120/240
- Volume: 45L
- Capacity: 20KG
- Weight: 256KG
- Dimension: 900x500x1180

HS50S

- Voltage: 380V
- Power: 2.8KW/3.6KW
- Speed (R/Min): 12/24/120/240
- Volume: 66L
- Capacity: 25KG
- Weight: 275KG
- Dimension: 1030x580x1230

SPIRAL MIXER

HS20



- Voltage: 220V
- Power: 1.1KW
- Speed (R/Min): 207
- Volume: 20L
- Capacity: 6KG
- Weight: 85KG
- Dimension: 668x409x854

HS140S



- Voltage: 380V
- Power: 2.8KW/5.6KW
- Speed (R/Min): 22/110/220
- Volume: 140L
- Capacity: 50KG
- Weight: 640KG
- Dimension: 1200x735x1370

PLANETARY MIXER

B-7L



- Voltage: 220V
- Power: 370W
- Capacity: 7L
- Flour Capacity: 0.5KG
- Net Weight: 17KG
- Dimension: 390*225*420mm

- Voltage: 220V
- Power: 2KW
- Capacity: 40L
- Flour Capacity: 6-8KG
- Net Weight: 130KG
- Dimension: 580*630*1050mm

B-40LB



PLANETARY MIXER



B5S

- Voltage: 220V
- Power: 0.5 W
- Speed (R/Min): 0-1000r/min
- Volume: 5.5L
- Capacity: 500G
- Egg Mixing Quantity: 500g
- Weight: 13KG
- Dimension: 380X240X375 mm

B7S

- Size: 380*240*405MM
- Voltage: 110V/220-240V /50-60Hz
- Power: 0.5 W
- Capacity: 7.5L
- Dough Mixing
- Quantity: 700g
- Egg Mixing Quantity: 700g
- Speed: 0-1000r/min
- Weight: 13.3Kg



KM10LB

- Voltage: 220V/50Hz
- Power: 750 W
- Speed (R/Min): 50/100/194
- Volume: 10L
- Capacity: 2.5KG
- Weight: 62KG
- Dimension: 400x520x720

KM20LB

- Voltage: 220V/50Hz
- Power: 1000 W
- Speed (R/Min): 48/95/186
- Volume: 20L
- Capacity: 5KG
- Weight: 79KG
- Dimension: 460x620x840

KM30LB

- Voltage: 220V/50Hz
- Power: 1500 W
- Speed (R/Min): 49/98/191
- Volume: 30L
- Capacity: 6.5KG
- Weight: 80KG
- Dimension: 470x650x840



B40FA

- Voltage: 220-380V
- Power: 1.5KW
- Speed (R/Min): 120/187/520
- Volume: 35L
- Capacity: 9KG
- Weight: 210KG
- Dimension: 650x620x1120

B60A

- Voltage: 380V
- Power: 2.2KW
- Speed (R/Min): 82/155/326
- Volume: 60L
- Capacity: 25KG
- Weight: 395KG
- Dimension: 910x730x1460



PLANETARY MIXER

B-60LB



- Voltage: 220V
- Power: 3KW
- Capacity: 60L
- Flour Capacity: 8-11KG
- Net Weight: 305KG
- Dimension: 610*650*1360mm

HS-10L

- Voltage: 220V
- Power: 750W
- Capacity: 10L
- Flour Capacity: 5KG
- Net Weight: 60KG
- Dimension: 540*315*650mm

HS-20L

- Voltage: 220V
- Power: 1.5KW
- Capacity: 20L
- Flour Capacity: 8KG
- Net Weight: 85KG
- Dimension: 700*500*770mm



HS-30L

- Voltage: 220V
- Power: 1.5KW
- Capacity: 30L
- Flour Capacity: 12KG
- Net Weight: 102KG
- Dimension: 770*550*850mm

HS-40L

- Voltage: 220V
- Power: 1.5KW
- Capacity: 40L
- Flour Capacity: 15KG
- Net Weight: 105KG
- Dimension: 770*550*850mm

HS-50L

- Voltage: 220V
- Power: 2.2KW
- Capacity: 50L
- Flour Capacity: 20KG
- Net Weight: 165KG
- Dimension: 880*530*920mm

HS-60L

- Voltage: 220V
- Power: 2.5KW
- Capacity: 60L
- Flour Capacity: 25KG
- Net Weight: 166KG
- Dimension: 880*530*920mm

ELECTRIC BAKERY OVEN



RB-110E

- Voltage: 220V
- Power: 3.2KW
- Capacity: 1 Deck/ 1 Tray
- Tray Suitable: 600X400 mm
- Weight: 68 KG
- Chamber Size: 640X455X180
- Dimension: 925X570X430

RB-120E

- Voltage: 220-380V
- Power: 6.6KW
- Capacity: 1 Deck/ 2 Tray
- Tray Suitable: 600X400 mm
- Weight: 75 KG
- Chamber Size: 860X670X220
- Dimension: 1260X805X535

RB-130E

- Voltage: 380V
- Power: 9KW
- Capacity: 1 Deck/ 3 Tray
- Tray Suitable: 600X400 mm
- Weight: 105 KG
- Chamber Size: 1300X670X220X3
- Dimension: 1770X840X615

RB-240E



- Voltage: 380V
- Power: 13.2KW
- Capacity: 2 Deck / 4 Tray
- Tray Suitable: 600x400mm
- Weight: 135KG
- Chamber Size: 860x670x220x2
- Dimension: 1260x805x1100

RB-260E

- Voltage: 380V
- Power: 18KW
- Capacity: 2 Deck / 6 Tray
- Tray Suitable: 600x400mm
- Weight: 190KG
- Chamber Size: 1300x670x220x6
- Dimension: 1700x805x1100

RB-360E



- Voltage: 380V
- Power: 19.8KW
- Capacity: 3 Deck / 6 Tray
- Tray Suitable: 600x400mm
- Weight: 206KG
- Chamber Size: 860x670x220x3
- Dimension: 1260x805x1515

RB-390E

- Voltage: 380V
- Power: 25.2KW
- Capacity: 3 Deck / 9 Tray
- Tray Suitable: 600x400mm
- Weight: 290KG
- Chamber Size: 1300x670x220x9
- Dimension: 1700x805x1515

GAS BAKERY OVEN

RB-120G



- Voltage: 220V
- Power: 0.1KW
- Capacity: 1 Deck / 2 Tray
- Tray Suitable: 600x400mm
- Weight: 99.5KG
- Chamber Size: 860x670x220
- Dimension: 1330x840x615

RB-130G

- Voltage: 220V
- Power: 0.1KW
- Capacity: 1 Deck / 3 Tray
- Tray Suitable: 600x400mm
- Weight: 105KG
- Chamber Size: 1300x670x220x3
- Dimension: 1770x840x615

RB-240G



- Voltage: 220V
- Power: 0.2KW
- Capacity: 2 Deck / 4 Tray
- Tray Suitable: 600x400mm
- Weight: 185KG
- Chamber Size: 860x670x220x2
- Dimension: 1330x840x1190

RB-260G

- Voltage: 220V
- Power: 0.2KW
- Capacity: 2 Deck / 6 Tray
- Tray Suitable: 600x400mm
- Weight: 256KG
- Chamber Size: 1300x670x220x6
- Dimension: 1770x840x1190



RB-360G

- Voltage: 220V
- Power: 0.3KW
- Capacity: 3 Deck / 6 Tray
- Tray Suitable: 600x400mm
- Weight: 256KG
- Chamber Size: 860x670x220x3
- Dimension: 1330x840x1660

RB-390G

- Voltage: 220V
- Power: 0.3KW
- Capacity: 3 Deck / 9 Tray
- Tray Suitable: 600x400mm
- Weight: 328KG
- Chamber Size: 1300x670x220x9
- Dimension: 1770x840x1660

YXY-20A

- Voltage: 220V
- Power: 0.1KW
- Capacity: 1 Deck / 2 Tray
- Tray Suitable: 600x400mm
- Weight: 99.5KG
- Chamber Size: 860x670x220
- Dimension: 1330x840x615

YXY-13A

- Voltage: 220V
- Power: 0.1KW
- Capacity: 1 Deck / 3 Tray
- Tray Suitable: 600x400mm
- Weight: 105KG
- Chamber Size: 1300x670x220x3
- Dimension: 1770x840x615



YXY-40A

- Voltage: 220V
- Power: 0.2KW
- Capacity: 2 Deck / 4 Tray
- Tray Suitable: 600x400mm
- Weight: 185KG
- Chamber Size: 860x670x220x2
- Dimension: 1330x840x1190

YXY-26A

- Voltage: 220V
- Power: 0.2KW
- Capacity: 2 Deck / 6 Tray
- Tray Suitable: 600x400mm
- Weight: 256KG
- Chamber Size: 1300x670x220x6
- Dimension: 1770x840x1190



YXY-60A

- Voltage: 220V
- Power: 0.3KW
- Capacity: 3 Deck / 6 Tray
- Tray Suitable: 600x400mm
- Weight: 256KG
- Chamber Size: 860x670x220x3
- Dimension: 1330x840x1660

YXY-90A

- Voltage: 220V
- Power: 0.3KW
- Capacity: 3 Deck / 9 Tray
- Tray Suitable: 600x400mm
- Weight: 328KG
- Chamber Size: 1300x670x220x9
- Dimension: 1770x840x1660



NFD40FF



- Voltage: 380V
- Power: 1.2+3.5KW
- Capacity: O:4 Tray / P:8 Tray
- Tray Suitable: 600x400mm
- Weight: 538KG
- Dimension: 1460X1190X1980

2 DECK OVEN WITH BELOW PROOFER

ELECTRIC DIGITAL OVEN

YXD-1AE



- Voltage: 220V, Power: 2.67KW
- Tray Capacity: 4
- Tray Size: 438x315x10
- Interior Size: 460x375x360
- Temperature: 50-300°C
- Steam: No
- Dimension: 595X606X570mm

CONVECTION OVEN

PROOFER

IP3TE8T

- Capacity: 8 Tray Proofer By Digital Panel
- Dimension: 1660X820X850

IP3TG8T

- Capacity: 8 Tray Proofer By Digital Panel
- Dimension: 1770X890X850



- Volts: 220V/50Hz
- Power: 2.6KW
- Production: 20Kg/hour
- Capacity: 13 Pans
- Dimension: 490*690*1660mm

FX-13



IP2TE8T

- Capacity: 8 Tray Proofer By Digital Panel
- Dimension: 1220X820X850

IP2TG8T

- Capacity: 8 Tray Proofer By Digital Panel
- Dimension: 1330X890X850



EB-08A

- Voltage: 220V
- Power: 1300W
- Capacity: 8 Ounce
- Dimension: 520X380X670mm



POP CORN MACHINE

EB-2488



POP CORN MACHINE

- Voltage: 220V
- Power: 1200W
- Capacity: 8 Ounce
- Dimension: 505X350X680mm

HEC-02

- Voltage: 220V/50Hz
- Power: 0.9KW
- Dimensions: 710x710x510mm



CANDY FLOSS MACHINE

YXD-266

- Voltage: 220V
- Power: 4.7KW
- Cooking Capacity: 8-12 Pcs
- Basket Qty: 4 Pcs
- Dimension: 810X600X640mm



ELECTRIC ROTISSERIE

YXD-268

- Voltage: 220V
- Power: 6.21KW
- Cooking Capacity: 12-16 Pcs
- Basket Qty: 4 Pcs
- Dimension: 1030X670X800mm

KIOSK ITEM

SY-110



ICE CRUSHER

- Voltage: 220V/50HZ
- Electricity: 3.5A
- Circumgyrate : 1400rpm
- Power: 250W
- Production: 1.8Kg./m
- Devotion: About 1.8Kg.
- Weight: 20Kg
- Dimension: 350X290X430mm

PE-2



- Voltage: 380V
- Power: 9.9KW
- Dimension: 534X607X950mm



ELECTRIC SHAWARMA MACHINE

WYE-791

- Voltage: 220V/50Hz
- Power: 9KW
- Gas: LPG
- Weight: 27Kg
- Dimension: 480X630X790mm

WYE-792

- Voltage: 220V/50Hz
- Power: 9.9KW
- Gas: LPG
- Weight: 31Kg
- Dimension: 530X630X920mm



GAS SHAWARMA MACHINE

SY-300T



- Voltage: 220V/50Hz
- Power: 0.75KW
- Speed Of Pressing: 25 R/MIN
- Production Efficiency: 300Kg/Hr
- Weight: 54Kg
- Dimension: 440X370X540mm

SUGAR CANE JUICER MACHINE





MARSSA ENTERPRISE

116D Rash Behari Avenue, 1st floor Kolkata: 700029

Email: marssa.enterprise@gmail.com



  +91 9717778911



Scan This QR For Connect With Us